



Panasonic®

TV / DVD Combination Operating Instructions

Model No. **PV-27DF4**

Getting Started

TV Operation

Disc Operation

Information



• Initial Setup and Connection Procedures are on page 18.



MULTI FORMAT PLAYBACK



*Ability to play back may depend on recording conditions.



As an **ENERGY STAR®** Partner, Matsushita Electric Corporation of America has determined that this product or product model meets the **ENERGY STAR®** guidelines for energy efficiency.



Please read these instructions carefully before attempting to connect, operate, or adjust this product. Please save this manual. Spanish Quick Use Guide is included. (Guía para rápida consulta en español está incluida.)

LSQ10836 A



Before Using

Congratulations

On your purchase of one of the most sophisticated and reliable products on the market today. Used properly, it will bring you and your family years of enjoyment. Please fill in the information below. The serial number is on the tag located on the back of your unit.

Date of Purchase _____

Dealer Purchased From _____

Dealer Address _____

Dealer Phone No. _____

Model No. _____

Serial No. _____

Accessories

Please check and identify the supplied accessories.

Use numbers indicated in parentheses when asking for replacement parts.

To order accessories, call toll free 1-800-332-5368.

1 Remote Control (EUR7724040)

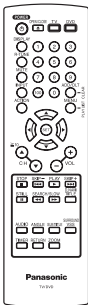

2 Batteries "AA"

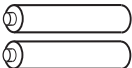

Safety Precaution

Be sure to read the following cautions carefully.

▲ WARNING

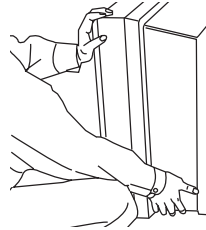

Always grasp bottom and front of unit as shown for proper balance.

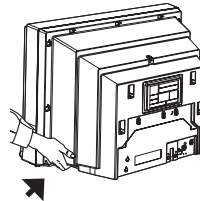

To avoid injury to hands, always hold unit by area shown with arrow when resting it on a flat surface.

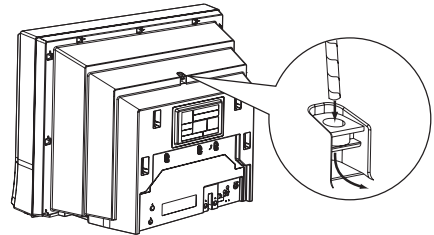

The unit may tip or fall if not situated on a stable surface, if pushed, or during an earthquake. Use a strong rope or chain (not included) to fasten the unit firmly to a strong wall support.

Table of Contents

Getting Started

Before Using.....	2
Safety Precautions/Mesures de sécurité.....	4
IMPORTANT SAFEGUARDS AND PRECAUTIONS	6
Information (Unit).....	8
Information (Disc).....	9
Location of Controls.....	11
Connections	14

TV Operation

Initial Setup -Ready to Play-	18
Tuning TV.....	19
TV Operation	22
MTS Broadcast / TV Stereo System.....	24
TV Timer Features.....	25
Closed Caption System.....	26
Video / Audio Menu.....	28
Weak Signal Display Feature.....	30
V-Chip Control Features	31
Display Feature	37

Disc Operation

Basic Disc Operation.....	38
Disc Operation -In PLAY mode-.....	40
DVD-RAM Operation.....	44
Disc Operation -Using Information Screen-	46
Special Disc Operation	50
Settings for DVD Operation	54

Information

Warning and Instruction Displays	59
Before Requesting Service.....	60
Spanish Quick Use Guide	
Guía rápida de uso en español - Conexión -	62
Guía rápida de uso en español - Funcionamiento del televisor -...63	
Guía rápida de uso en español - Funcionamiento del disco-	65
Limited Warranty	68
Customer Services Directory.....	69
Glossary.....	70
Specifications	71
Index.....	72

Safety Precautions/Mesures de sécurité

⚠ WARNING

TO PREVENT FIRE OR SHOCK HAZARD, DO NOT EXPOSE THIS EQUIPMENT TO RAIN OR MOISTURE.

⚠ CAUTION

TO PREVENT ELECTRIC SHOCK, MATCH WIDE BLADE OF PLUG TO WIDE SLOT IN WALL SOCKET. FULLY INSERT.

AVERTISSEMENT :

AFIN DE PRÉVENIR TOUT RISQUE D'INCENDIE OU DE CHOCS ÉLECTRIQUES, NE PAS EXPOSER CET APPAREIL À LA PLUIE OU À UNE HUMIDITÉ EXCESSIVE.

Attention :

POUR ÉVITER LES CHOCS ÉLECTRIQUES, INTRODUIRE LA LAME LA PLUS LARGE DE LA FICHE DANS LA BORNE CORRESPONDANTE DE LA PRISE ET POUSSER JUSQU'AU FOND.

FCC WARNING :

ANY UNAUTHORIZED CHANGES OR MODIFICATIONS TO THIS EQUIPMENT WOULD VOID THE USER'S AUTHORITY TO OPERATE.

FCC NOTICE:

This equipment has been tested and found to comply with part 15 of the FCC Rules. These limits are designed to provide reasonable protection against harmful interference when operated in a residential environment. If this equipment does cause interference to radio or television reception, which can be determined by turning the equipment off and on, use the equipment in another location and/or utilize an electrical outlet different from that used by the receiver. If necessary, consult the dealer or an experienced radio/TV technician for help. You may find the booklet, "Something About Interference" available from FCC local regional offices helpful.

This product utilizes both a Cathode Ray Tube (CRT) and other components that contain lead. Disposal of these materials may be regulated in your community due to environmental considerations. For disposal or recycling information please contact your local authorities, or the Electronics Industries Alliance: <<http://www.eiae.org>>

CAUTION:

UNIT IS A CLASS I LASER PRODUCT.

HOWEVER THIS UNIT USES A VISIBLE LASER BEAM WHICH COULD CAUSE HAZARDOUS RADIATION EXPOSURE IF DIRECTED. BE SURE TO OPERATE THE UNIT CORRECTLY AS INSTRUCTED.

WHEN THIS UNIT IS PLUGGED TO THE WALL OUTLET, DO NOT PLACE YOUR EYES CLOSE TO THE OPENING OF THE DISC TRAY AND OTHER OPENINGS TO LOOK INTO THE INSIDE OF THIS UNIT.

USE OF CONTROLS OR ADJUSTMENTS OR PERFORMANCE OF PROCEDURES OTHER THAN THOSE SPECIFIED HEREIN MAY RESULT IN HAZARDOUS RADIATION EXPOSURE.

DO NOT OPEN COVERS AND DO NOT ATTEMPT TO REPAIR THE UNIT YOURSELF. REFER SERVICING TO QUALIFIED PERSONNEL.

CAUTION:

LASER RADIATION WHEN OPEN. DO NOT STARE INTO BEAM.

ATTENTION:

RAYONNEMENT LASER EN CAS D'OUVERTURE.

NE PAS REGARDER DANS LE FAISCEAU.

(Inside of product)

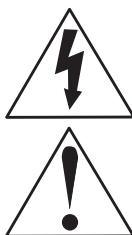
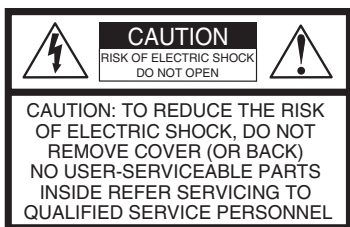

This symbol warns the user that uninsulated voltage within the unit may have sufficient magnitude to cause electric shock.

Therefore, it is dangerous to make any kind of contact with any inside part of this unit.

This symbol alerts the user that important literature concerning the operation and maintenance of this unit has been included.

Therefore, it should be read carefully in order to avoid any problems.

Apparatus Claims of U.S. Patent Nos. 4,631,603, 4,577,216, 4,819,098, and 4,907,093, licensed for limited viewing uses only.

This product incorporates copyright protection technology that is protected by method claims of certain U.S. Patents and other intellectual property rights owned by Macrovision Corporation and other rights owners. Use of this copyright protection technology must be authorized by Macrovision Corporation, and is intended for home and other limited viewing uses only unless otherwise authorized by Macrovision Corporation. Reverse engineering or disassembly is prohibited.

This television receiver provides display of television closed captioning.

IMPORTANT SAFEGUARDS AND PRECAUTIONS

WARNING

TO REDUCE THE RISK OF ELECTRIC SHOCK, FIRE, INJURY TO PERSONS OR DAMAGE TO THIS PRODUCT, READ AND RETAIN ALL SAFETY AND OPERATING INSTRUCTIONS. HEED ALL WARNINGS IN THE MANUAL AND ON THE PRODUCT.

INSTALLATION

1 POWER SOURCE CAUTION

Operate only from power source indicated on unit or in this manual. If uncertain, have your Electric Utility Service Company or Video Products Dealer verify your home power source.

2 POWER CORD PLUG

For safety, this unit has a polarized type plug (one wide blade), or a three-wire grounding type plug. Always hold the plug firmly and make sure your hands are dry when plugging in or unplugging the AC power cord. Regularly remove dust, dirt, etc. on the plug.

POLARIZED PLUG CAUTION:

The plug fits into outlet only one way. If it cannot be fully inserted, try reversing it. If it still will not fit, have an electrician install the proper wall outlet. Do not tamper with the plug.

GROUNDING PLUG CAUTION:

The plug requires a three-hole grounding outlet. If necessary, have an electrician install the proper outlet. Do not tamper with the plug.

3 POWER CORD

To avoid unit malfunction, and to protect against electrical shock, fire or personal injury:

- Keep power cord away from heating appliances and walking traffic. Do not rest heavy objects on, or roll such objects over the power cord.
- Do not tamper with the cord in any way.
- An extension cord should have the same type plug (polarized or grounding) and must be securely connected.
- Overloaded wall outlets or extension cords are fire hazards.
- Frayed cords, damaged plugs, and damaged or cracked wire insulation are hazardous and should be replaced by a qualified electrician.

4 DO NOT BLOCK VENTILATION HOLES

Ventilation openings in the cabinet release heat generated during operation. If blocked, heat build-up may result in a fire hazard or heat damage to discs.

For your protection:

- Never cover ventilation slots while unit is ON, or operate unit while placed on a bed, sofa, rug, or other soft surface.
- Avoid built-in installation, such as a book case or rack, unless properly ventilated.

5 AVOID EXTREMELY HOT LOCATIONS OR SUDDEN TEMPERATURE CHANGES

Do not place unit over or near a heater or radiator, in direct sunlight, inside closed vehicles, in high temperature locations [over 95 °F (35 °C)], or in over 75 % humidity. If unit is suddenly moved from a cold place to a warm one, moisture may condense in unit and on the disc causing damage. Never subject unit to vibration, impact, or place it so that the surface is tilted as internal parts may be seriously damaged.

6 TO AVOID PERSONAL INJURY

- Never place unit on support or stand that is not firm, level, and adequately strong. The unit could fall causing serious injury to a child or adult and damage to the unit.
- Move any appliance and cart combination with care. Quick stops, excessive force, and uneven surfaces may cause objects to overturn.
- Carefully follow all operating instructions.



USING THE UNIT

Before unit is brought out of storage or moved to a new location, refer again to the INSTALLATION section of these safeguards.

1 KEEP UNIT WELL AWAY FROM WATER OR MOISTURE,

such as vases, sinks, tubs, etc.

2 IF EXPOSED TO RAIN, MOISTURE, OR STRONG IMPACT,

unplug unit and have it inspected by a qualified service technician before use.

3 ELECTRICAL STORMS

During a lightning storm, or before leaving unit unused for extended periods of time, disconnect all equipment from the power source as well as the antenna and cable system.

4 WHEN UNIT IS PLUGGED IN

- DO NOT OPERATE IF:
 - liquid has spilled into unit.
 - unit was dropped or otherwise damaged.
 - unit emits smoke, odours, or noises.
 Immediately unplug unit, and have it inspected by a service technician to avoid potential fire and shock hazards.
- Never drop or push any object through openings in unit. Touching internal parts may cause electric shock or fire hazard. Do not put any foreign object on the tray.
- Keep magnetic objects, such as speakers, away from unit to avoid electrical interference.

5 USING ACCESSORIES

Use only accessories recommended by the manufacturer to avoid risk of fire, shock, or other hazards.

6 CLEANING UNIT

Unplug unit. Use a clean, dry, chemically untreated cloth to gently remove dust or debris. DO NOT USE cleaning fluids, aerosols, or forced air that could over-spray, or seep into unit and cause electrical shock. Any substance, such as wax, adhesive tape, etc. may mar the cabinet surface. Exposure to greasy, humid, or dusty areas may adversely affect internal parts.

OUTDOOR ANTENNA INSTALLATION

1 SAFE ANTENNA AND CABLE CONNECTION

An outside antenna or cable system must be properly grounded to provide some protection against built up static charges and voltage. Section 810 of the National Electrical Code, ANSI/NFPA 70 (in Canada, part 1 of the Canadian Electrical Code) provides information regarding proper grounding of the mast and supporting structure, grounding of the lead-in wire to an antenna discharge unit, size of grounding conductors, location of antenna discharge unit, connection to grounding electrodes, and requirements for the grounding electrode.

2 KEEP ANTENNA CLEAR OF HIGH VOLTAGE POWER LINES OR CIRCUITS

Locate an outside antenna system well away from power lines and electric light or power circuits so it will never touch these power sources should it ever fall. When installing antenna, absolutely never touch power lines, circuits or other power sources as this could be fatal.

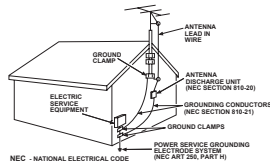

SERVICE

1 DO NOT SERVICE PRODUCT YOURSELF

If, after carefully following detailed operating instructions, the unit does not operate properly, do not attempt to open or remove covers, or make any adjustments not described in the manual. Unplug unit and contact a qualified service technician.

2 REPLACEMENT OF PARTS

Make sure the service technician uses only parts specified by the manufacturer, or have equal safety characteristics as original parts. The use of unauthorized substitutes may result in fire, electric shock, or other hazards.

3 SAFETY CHECK AFTER SERVICING

After unit is serviced or repaired, request that a thorough safety check be done as described in the manufacturer's service literature to ensure video unit is in safe operating condition.

Information (Unit)

Loading the Batteries

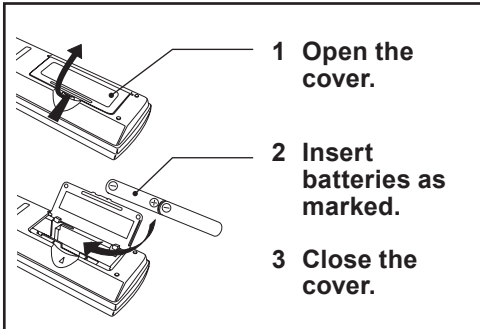

- Insert so the poles (+ and -) match those in the remote control.
- Do not use rechargeable type batteries.

Do not:

- Mix old and new batteries.
- Use different types at the same time.
- Heat or expose to flame.
- Take apart or short circuit.
- Attempt to recharge alkaline or manganese batteries.
- Use batteries if the covering has been peeled off.

Mishandling of batteries can cause electrolyte leakage which can damage items the fluid contacts and may cause a fire. Remove if the remote control is not going to be used for a long period of time. Store in a cool, dark place.

DST (Daylight Saving Time)

Unit auto adjusts clock for DST (Daylight Saving Time.)

■ Spring (First Sunday in April)

DST: ON → Sets clock ahead one hour.





■ Autumn (Last Sunday in October)

DST: ON → Turns clock back one hour.

- If your area does not observe Daylight Saving Time, select DST : OFF (see "Manual Clock Setting" on page 20).

Information (Disc)

Discs that can be played

Disc type	Disc Logo	Indication in these operating instructions
DVD-Video		<div style="border: 1px solid black; padding: 5px; display: inline-block;">DVD-V</div> (DVD-Video)
		
DVD-R*1		
DVD-RAM*2		
CD		<div style="border: 1px solid black; padding: 5px; display: inline-block;">CD</div> (CD-DA)
CD-R		
CD-RW		

Do not use irregularly shaped discs (e.g. heart-shaped), as these can damage the unit.

*1 DVD-Video formatted discs [finalized].

*2 Discs recorded using Version 1.1 of the Video Recording Format.

Discs that cannot be played

DVD with Region No. other than "1" or "ALL", DVD from PAL system, DVD-ROM, DVD+R, DVD-AUDIO, DVD-RW, DVD+RW, CD-ROM, CDV, CVD, CD-G, CD-TEXT, SACD, Photo-CD, Video CD.

Note

It may not be possible to play CD-R, CD-RW, DVD-R and DVD-RAM in all cases due to the type of disc or condition of the recording.

DVDs that can be played

You can play discs with these symbols.



Playing DVDs

The producer of these discs can control how they are played so you may not always be able to control play as described in these operating instructions. Read the disc's instructions carefully.

DVD-R discs

Panasonic DVD-R recorded and finalized* on a Panasonic DVD video recorder are played as DVD-Video on this unit.

DVD-RAM discs

DVD-RAM discs must meet the following conditions for this unit to be able to play them.

Type	<ul style="list-style-type: none"> • Non-cartridge discs • Discs that can be removed from their cartridges (TYPE 2 and 4)
Capacity	<ul style="list-style-type: none"> • 12 cm (5") 9.4 GB (double-sided) and 4.7 GB (single-sided) • 8 cm (3") 2.8 GB (double-sided)

Remove TYPE 2 and 4 discs from their cartridges before use, then return them when you are finished. Read the instructions for the disc carefully.

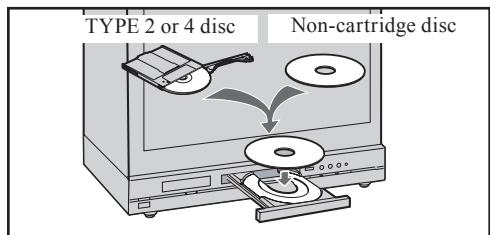

Some parts of the disc, for example where one program ends and another begins, may not play smoothly.

CD-R and CD-RW discs

This unit can play CD-R and CD-RW if they are formatted as CD-DA (digital audio) and finalized*.

*A process that allows play on compatible equipment.

Disc Handling

Handling precautions

- Sticking a label on the disc may impair DVD-R playback.
- Do not attach sticker to disc. (Do not use discs with exposed adhesive from tape or left over peeled-off stickers.)
- Only hold disc by edges as shown below. Fingerprints, dirt and scratches can cause skipping and distortion.
- Do not write on label side of disc.
- Never use record cleaning sprays, benzene, thinner, static electricity prevention liquids, or any other solvent.
- Do not try to close disc tray when disc is not properly placed.

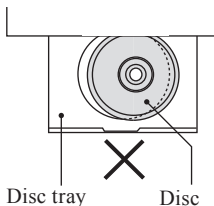
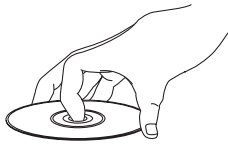

Disc tray Disc

To clean disc surface

With a soft, damp (water only) cloth, gently wipe from the center hole to the outer edge as shown below. (Wiping in a circular pattern will scratch the surface.)

- DVD-RAM, DVD-R :

Clean only with the DVD-RAM disc cleaner available. Never use cloths or cleaners for CDs, etc.



If disc is brought from a cold to a warm environment, moisture may form on the disc

Wipe away moisture with a soft, dry, lint-free cloth before using disc. (See above.)

Improper disc storage

Discs can be damaged if stored or left in these environment:

- Exposed to direct sunlight.
- Areas that are humid or dusty.
- Near heat (i.e. heater, radiator, etc.).

Region Management Information

This unit is designed and manufactured to respond to the Region Management Information that is recorded on a DVD disc. If the Region number described on the DVD disc does not correspond to the Region number of this unit, this unit cannot play this disc.

For U.S.A. and Canada

- The region number of this player is "1".
- The player will play DVD-Video marked with labels bearing "1" or "ALL".

Example:



Location of Controls

Remote Control Buttons

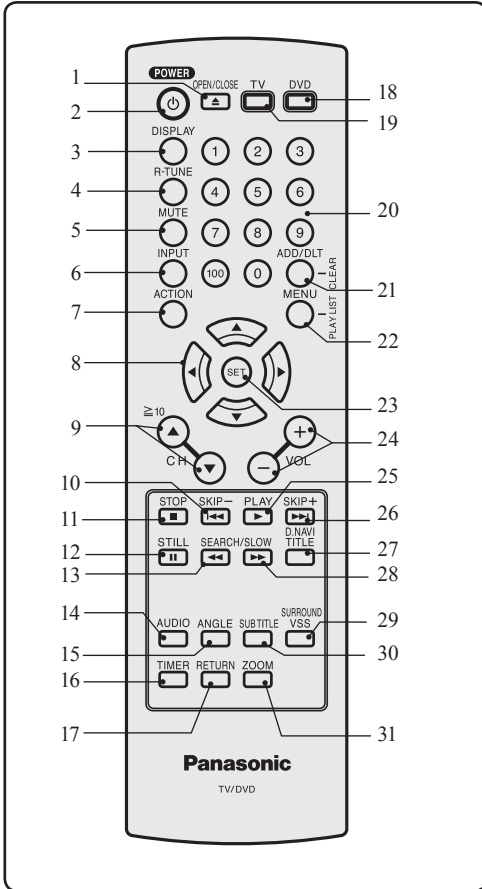

1	OPEN / CLOSE	Opens or closes the disc tray.
2	POWER	Turns the unit on or off.
3	DISPLAY	Displays the TV status and clock. In DVD mode, displays disc and unit information.
4	RAPID TUNE	Displays the last channel you were watching.
5	MUTE	Mutes the sound instantly.
6	INPUT	Changes input source.
7	ACTION	Displays Main Menu.
8	SELECT	Controls navigation around on-screen menu.
9	CHANNEL UP/DOWN	Selects a channel.
10	SKIP-	Skips back one chapter or track. Goes to previous menu screen.

11	STOP	Stops playback.
12	STILL	Pauses picture in Playback mode and frame advance picture in Still mode.
13	SEARCH << / SLOW-	Activates reverse rapid scene search in Play mode. Increases reverse slow motion speed in still mode. (Up to 5 levels)
14	AUDIO	Selects the desired audio mode.
15	ANGLE	Selects the desired angle in DVD mode.
16	TIMER	Set ON TIMER or SLEEP TIMER.
17	RETURN	Returns to DVD menu screen.
18	DVD	Set to DVD mode.
19	TV	Sets to TV mode.
20	NUMBER KEYS	Selects a channel directly.
21	ADD/DELETE/ CLEAR	Adds or deletes a channel. Cancels an item on the screen.
22	MENU / PLAY LIST	Displays DVD menu. Displays Play List. (DVD-RAM)
23	SET	Sets selected menu.
24	VOLUME UP/DOWN	Adjusts volume.
25	PLAY	Begins playback.
26	SKIP+ >>	Skips one chapter or track. Goes to next menu screen.
27	TITLE / D.NAVI	Selects the desired title by number on some DVDs. Displays Direct Navigator. (DVD-RAM).
28	SEARCH >> / SLOW+	Activates forward rapid scene search in Play mode. Increases forward slow motion speed in still mode. (Up to 5 levels)
29	SURROUND / VSS	Creates a deeper, 3-D sound effect.
30	SUB TITLE	Selects a different subtitle language.
31	ZOOM	Enlarges specific portions of DVD picture.

Unit Buttons

■ Front View

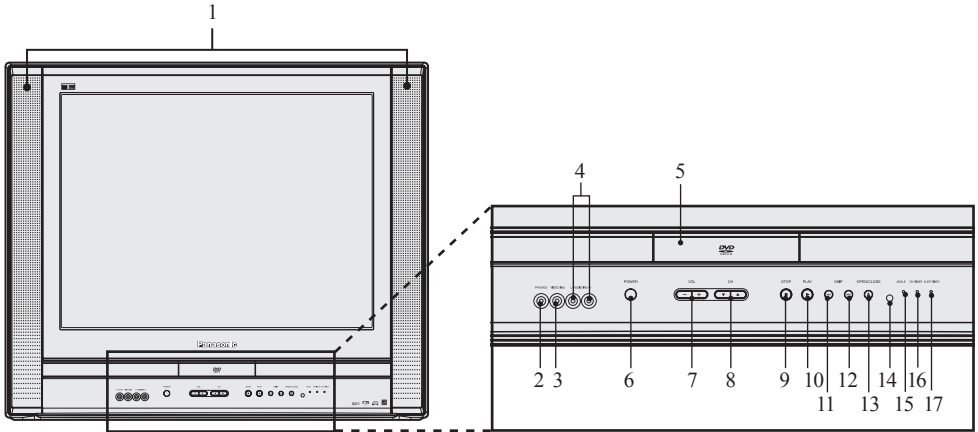

1	Built In Speakers	Equipped with 2 front speakers.
2	Phones Jack	Connect an ear phone or headphones.
3	Video Input Connector 2	Connect from other component. (LINE 2)
4	Audio Input Connector 2	Connect from other component. (LINE 2)
5	Disc Tray	Place compatible discs here.
6	POWER	Turns the unit on or off.
7	VOLUME UP/DOWN	Adjusts volume.
8	CHANNEL UP/DOWN	Selects a channel.
9	STOP	Stops playback.
10	PLAY	Begins playback.
11	SKIP-	Skips back one chapter or track. Goes to previous menu screen.
12	SKIP+	Skips one chapter or track. Goes to next menu screen.
13	OPEN/CLOSE	Opens or closes the disc tray.

14	Remote Sensor	Receives infrared signal from remote control.
15	ANGLE Indicator (RED)	Lights up when a scene recorded at multiple angles is detected. (DVD only)
16	ON TIMER Indicator (ORANGE)	Lights when the On Timer is set.
17	SLEEP TIMER Indicator (GREEN)	Lights when the Sleep-Timer is set.

■ Rear View

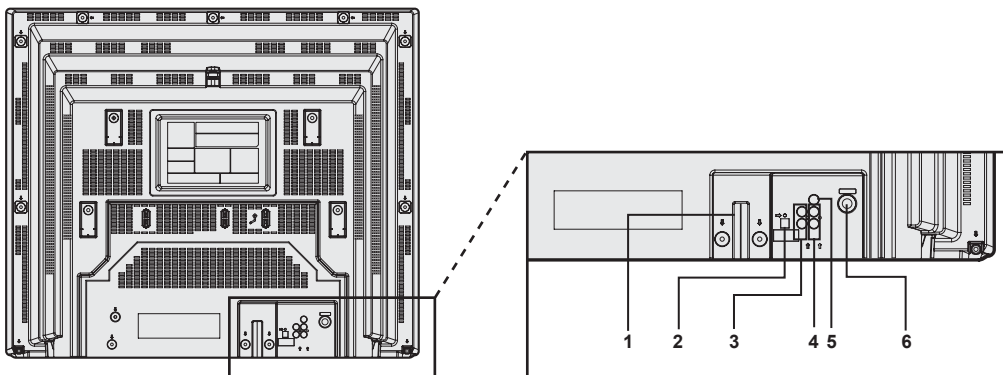

1	AC Power Plug	When plugged into an AC outlet, this unit consumes 1.5 W of electric power in OFF condition.
2	Optical digital audio output connector	Outputs audio signal. (Digital)
3	Audio Output Connector (L/R)	Outputs audio signal. (Analog)
4	Audio Input Connector 1	Connect from other component. (LINE 1)
5	Video Input Connector 1	Connect from other component. (LINE 1)
6	VHF/UHF Antenna Input Terminal	Input terminal for an antenna or cable box signal.

Connections

Notes on connections

- Turn off the power supply for all components before making any connections.
- If the cables necessary for connecting a component to the system are not included with the component or available as an option, you may need to fashion a cable to suit the component concerned.
- Read the instruction manual for each system component carefully before connecting it.

Connecting the RF in Terminal

⚠ CAUTION

Overtightening “Nut type” RF coaxial cables may damage jacks. Finger tighten only.

■ Antenna Connection

Connect the cable from Antenna to the VHF/UHF terminal on the unit.

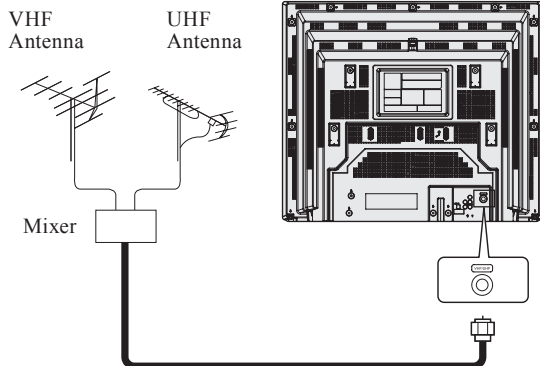

■ Cable Connection

Connect the cable supplied by your local cable company to VHF/UHF terminal on the unit.

Note to CABLE system installer:

This reminder is provided to call the CABLE (Cable TV) System Installer's attention to Article 820-40 of the NEC that provides guidelines for proper grounding and, in particular, specifies that the cable ground shall be connected to the grounding system of the building, as close to the point of cable entry as practical.

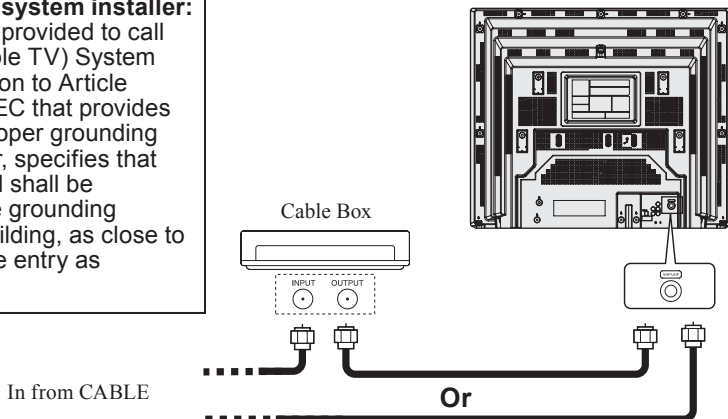

Connecting the “1, 2” AV Input Terminals

Connects VCRs and other peripheral equipment

■ AV Input terminal 1 is used

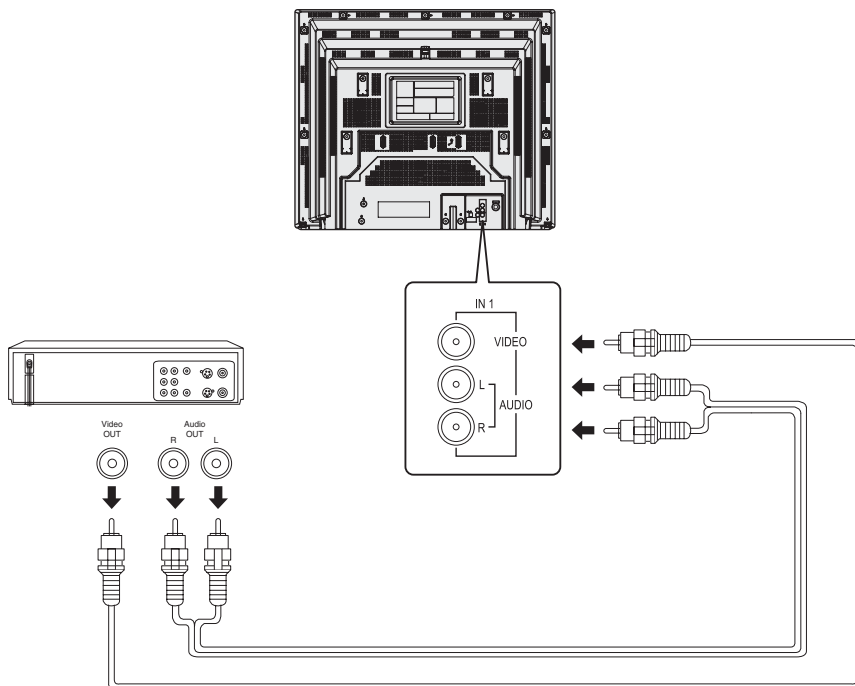

Notes

- Similar connections are available at the “1, 2” AV input terminals.
- AV Input terminal 2 is located on the front of the unit.

Connecting the Audio Output Terminal

Enjoy the powerful movie theater and hall-like sound available with multiple channel audio found on DVDs by connecting an amplifier and speakers. There are two types of connection, digital and analog.

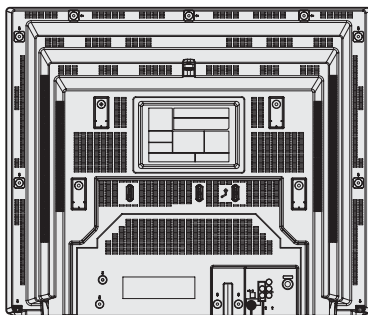

■ Digital connection

Connect an amplifier with Dolby Digital or DTS decoders to enjoy surround sound.

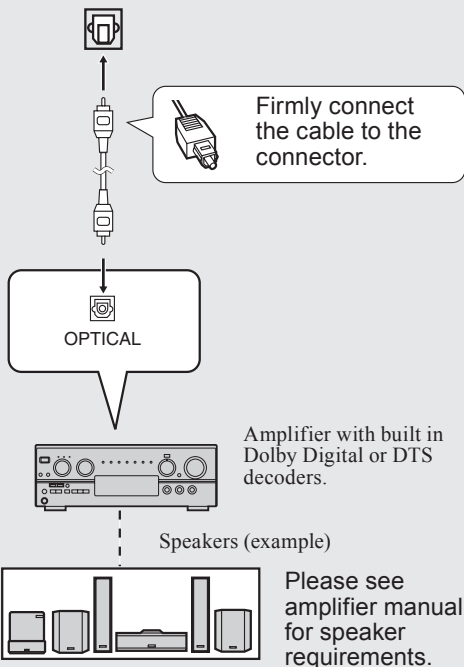

■ Analog connection

Connect an amplifier to enjoy high-quality stereo sound with sampling frequencies of 96 kHz.

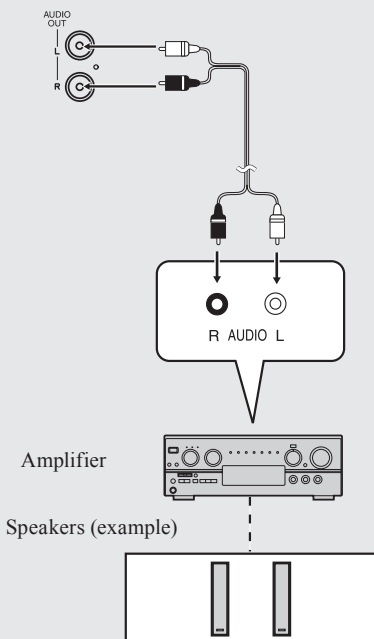

✓ Check List

- Turn down the volume, then turn this unit, as well as other equipment to be connected, off before proceeding with connection.
- Do not block ventilation holes of any equipment and arrange it so that air can circulate freely.

Enjoying digital audio output from the digital audio output connector

Notes on audio output from the optical digital audio output connector

Disc	Sound recording format	Optical digital audio output from connector
DVD-V	Dolby Digital	Dolby Digital bitstream (1-5.1 ch) or PCM (48 kHz sampling/16 bit only)*1
	Linear PCM (48/96 kHz 16/20/24 bit)	Linear PCM (2ch) (48 kHz sampling/16 bit only)*2
	dts	Bitstream or PCM (48 kHz sampling/16 bit only)*1
DVD-RAM	Dolby Digital	Dolby Digital bitstream (1-5.1 ch) or PCM (48 kHz sampling/16 bit only)*1
	Linear PCM (48 kHz 16 bit)	Linear PCM (2ch)
CD	Linear PCM	Linear PCM (44.1 kHz sampling)

*1 The type of audio output from the connector can be selected by adjusting the Settings for DVD Operation. (See pages 56-57.)

*2 When "LPCM" is set to OFF in the DVD Main Menu, only 48 kHz sampling/16 bit is output. When set to ON, sampling of sound quality greater than 48 kHz/16 bit is reduced to 48 kHz/16 bit. (See pages 56-57.)

Manufactured under license from Digital Theater Systems, Inc. US Pat. No's. 5,451,942, 5,956,674, 5,974,380, 5,978,762, 6,487,535 and other U.S. and world-wide patents issued and pending. "DTS" and "DTS 2.0 + Digital Out" are trademarks of Digital Theater Systems, Inc. Copyright 1996, 2003 Digital Theater Systems, Inc. All Rights Reserved.

Manufactured under license from Dolby Laboratories. "Dolby," "Pro Logic," and the double-D symbol are trademarks of Dolby Laboratories.

For your reference:

- Dolby Digital is a digital sound compression technique developed by the Dolby Laboratories Licensing Corporation. Supporting 5.1-channel surround sound, as well as stereo (2-channel) sound, this technique enables a large quantity of sound data to be efficiently recorded on a disc.
- Linear PCM is a signal recording format used in CDs. While CDs are recorded in 44.1 kHz/16 bit, DVDs are recorded in 48 kHz/16 bit up to 96 kHz/24 bit.
- If you have a Dolby Pro Logic Surround decoder, you will obtain the full benefit of Pro Logic from the same DVD movies that provide full 5.1 channel Dolby Digital soundtracks, as well as from titles with the Dolby Surround mark. For information on Panasonic Dolby Pro Logic Surround Sound Decoders please contact your local dealer.

IMPORTANT NOTE:

Caution for optical digital audio output connector:

- When connecting an amplifier (with an optical digital input connector) which does not contain the Dolby Digital or dts decoder, be sure to select "PCM" at "Dolby Digital" and "PCM" at "dts" in the Settings for DVD Operation "Selecting AUDIO OUTPUT" (see pages 56-57). Otherwise, any attempt to play DVDs may cause such a high level of noise that it may be harmful to your ears and damage your speakers.
- Be sure to refer to pages 56-57 regarding output settings of Dolby Digital, dts, and PCM.
- CDs can be played as usual.

Note

- Some dts decoders which do not support DVD-dts Interface may not work properly with the unit.

Initial Setup -Ready to Play-

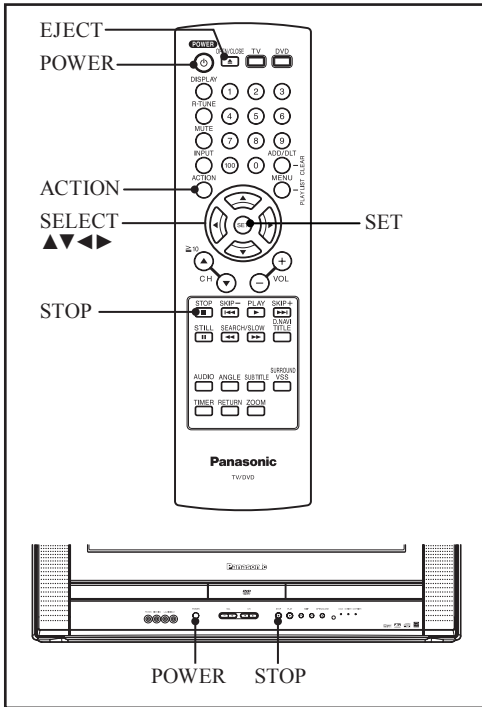

- Function buttons are void during Initial Setup.
- If Auto Clock Set takes more than 30 minutes, press STOP and perform settings manually. (See pages 19-21.)

Case 1

Settings are made automatically. When complete, this screen appears.

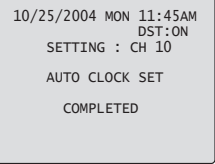

Case 2

If setup is incomplete, the following screen appears. Check connection of Antenna/Cable to the RF in Terminal, then try manually to set the clock as follows.

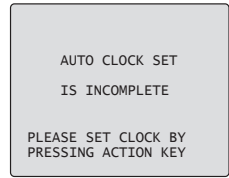

Initial Setup (Ready to Play)

Please make all cable or antenna connections before powering on. Plug the unit power cord into an AC wall outlet.

Press POWER on the remote or unit. Auto channel and clock set starts.

- If you use a cable box, turn it on and set it to the Public Broadcasting Service (PBS) channel in your time zone. If you use a DSS receiver, it must be turned off.

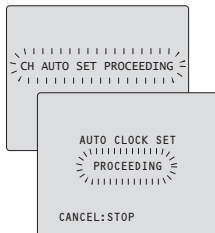

a. Press ACTION on the Remote to display SET CLOCK Menu screen.

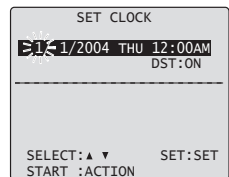

b. Press ▲▼ to select the month and press SET to set. In the same manner, select and set the date, year, time, and DST (Daylight Saving Time).

- Press ◀ repeatedly to move the cursor. Press ▲▼ to make a correction.

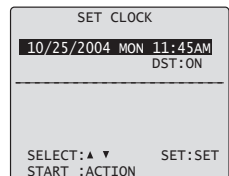

c. Press ACTION twice to start CLOCK and exit.

Tuning TV

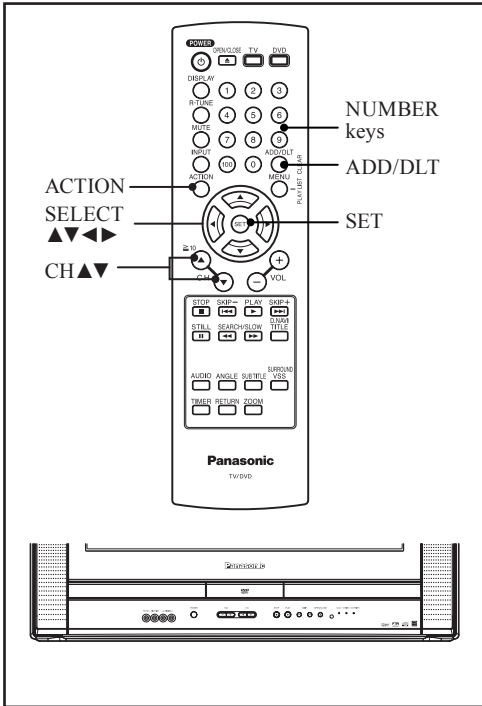

4 Press ▲▼ to select “ANTENNA,” then press SET to set your antenna system (“TV” or “CABLE”).

5 Press ▲▼ to select “AUTO SET,” then press SET.

- After Channel Auto Set is finished, Clock Auto Set will be performed. (If clock is set manually, Clock Auto Set will not be performed.)

Add or Delete a Channel

■ To add channel:

Select channel with NUMBER keys and press ADD/DLT.



■ To delete channel:

Select channel with CH ▲▼ or NUMBER keys and press ADD/DLT.

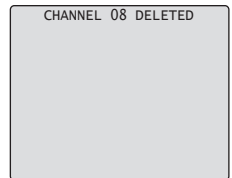

Automatic Channel Setting

1 Press ACTION to display MAIN MENU.

2 Press ▲▼◀▶ to select “CH.”

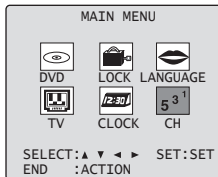

3 Press SET.

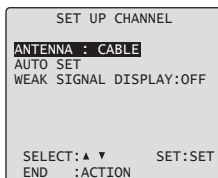

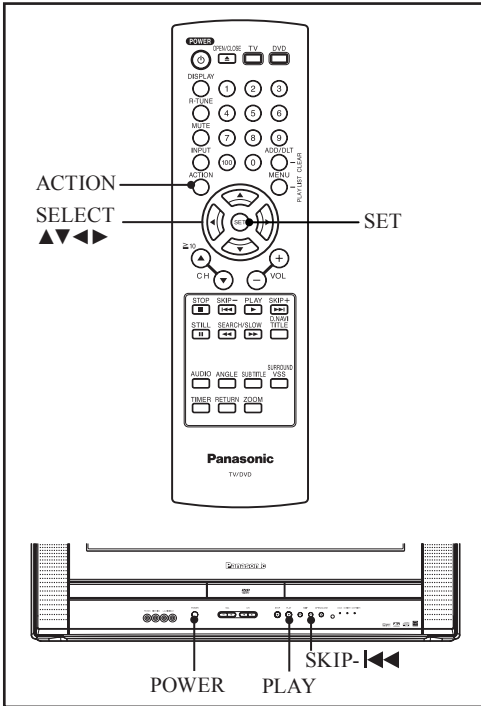

Manual Clock Setting

- 1 Press **ACTION** to display **MAIN MENU**.
- 2 Press **▲▼◀▶** to select **“CLOCK.”**

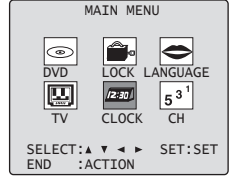

- 3 Press **SET**.
 (“TIME ZONE ADJUST” appears only when auto clock is set.)

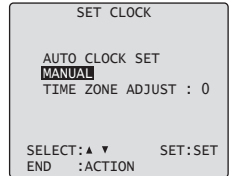

- 4 Press **▲▼** to select **“MANUAL,”** then press **SET**.

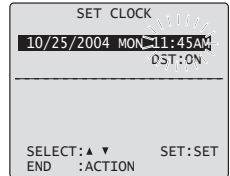

- 5 Press **▲▼** and press **SET** to select and set the month, date, year, time, and DST (Daylight Saving Time).
 To Make Corrections, repeatedly press **◀** to move to error, then correct.

- 6 Press **ACTION** twice to start the clock and exit this mode.

Automatic Clock Setting

- 1 Press **ACTION** to display **MAIN MENU**.
- 2 Press **▲▼◀▶** to select **“CLOCK.”**

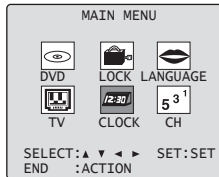

- 3 Press **SET**.

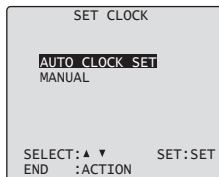

- 4 Press **▲▼** to select **“AUTO CLOCK SET,”** then press **SET**.

Time Zone Adjust

(Only when Auto Clock is set.)

1 Press **▲▼◀▶** to select **“CLOCK.”**

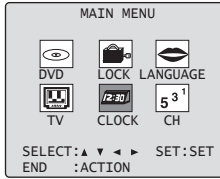

2 Press **SET**.

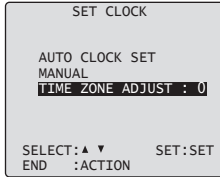

3 Press **▲▼** to select **“TIME_ZONE ADJUST”** and press **SET** to subtract or add hour(s) as necessary.

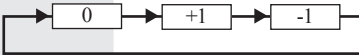
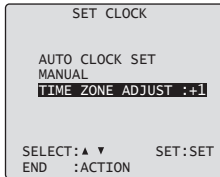

4 Press **ACTION** twice to exit.

Note

- “TIME_ZONE ADJUST” returns to “0” if clock is set manually.

Change Language Setting

1 Press **ACTION** to display **MAIN MENU**.

2 Press **▲▼◀▶** to select **“LANGUAGE.”**

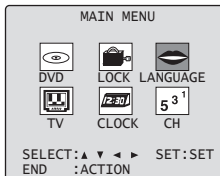

3 Press **SET** repeatedly.

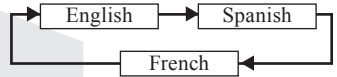

For English

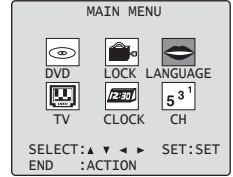

For Spanish

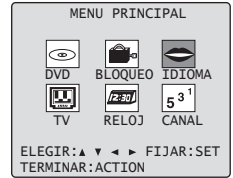

For French

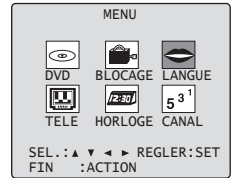

4 Press **ACTION** to exit.

Reset all unit Memory Functions

Returns to factory setting. Use if relocating unit, or if Initial Setup needs to be redone.

1 Turn the unit **Power on**.

2 Press and hold both **PLAY** and **SKIP-◀◀** on the unit for more than **5 seconds**.

- The power will shut off.

3 Perform **“Initial Setup”** on page 18.

TV Operation

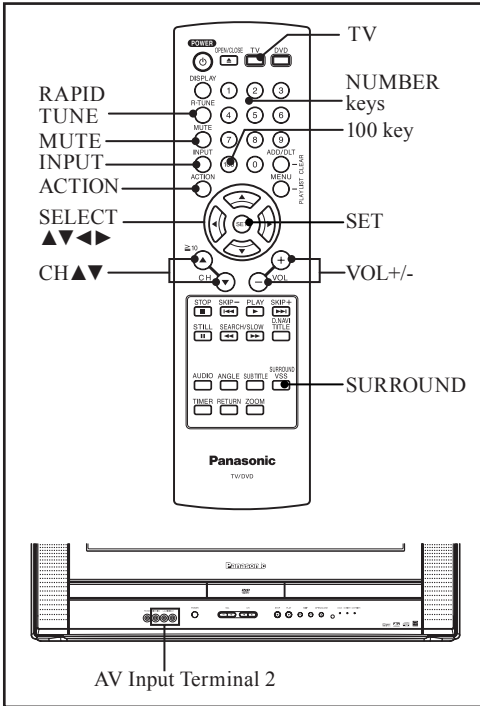

If a remote control button does not work when pressed, press the TV button on the remote and try the button again.

Selecting Input Mode

Method 1:

Press CH ▲▼. The display will change as follows.

Notes

- The diagram at right is an example.
- TV CH 2 and CABLE CH 1 represent the lowest channels in memory, while TV CH 69 and CABLE CH 125 represent the highest channels in memory.

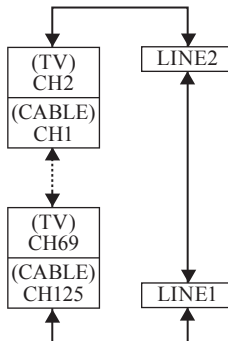

Method 2:

Press INPUT. The display will change as follows.



Method 3:

- 1 Press ACTION for MAIN MENU.
- 2 Press ▲▼◀▶ to select "TV", then press SET for SET UP TV screen.

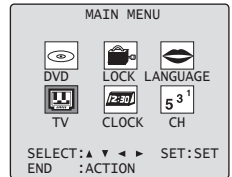

- 3 Press ▲▼ to select "INPUT SELECT," and then press SET to select "TUNER", "LINE 1", or "LINE 2."

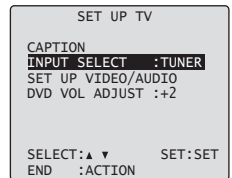

- 4 Press ACTION twice to exit this mode.

LINE 1:

Signal of source connected to AV Input terminal 1 is displayed. (Rear of the unit.)

LINE 2:

Signal of source connected to AV Input terminal 2 is displayed.

TUNER:

Signal of source connected to VHF/UHF terminal is displayed.

Using the CH/VOL Button

Select desired channel:

Press CH ▲▼ or NUMBER keys.

Adjust desired volume level:

Press VOL + or VOL -.

Using the Number and 100 keys

When selecting CABLE channels 100 to 125 with the NUMBER keys, first press the 100 key, and then enter the remaining two digits.

Example 1:

To select channel 125, first press the 100 key, then 2, then 5.

Example 2:

To select channel 12, first press the 1 key, then 2.

Example 3:

To select channel 2, first press the 0 key, then 2.

Rapid Tune

Press **R-TUNE** to display the last channel you were watching.

Audio Mute

Press **MUTE** to instantly mute the sound. Press again to restore the previous sound level.

Surround Sound System

You can hear a deeper, 3-D sound effect using just the unit's two front speakers.

Press **SURROUND**.

• "SURROUND ON" is displayed.

To Cancel, press SURROUND.

Notes

- Surround sound effect is not available for normal (mono) broadcasts.
- The surround effect (TV mode only) is not output to Audio Output L/R Connector.

MTS Broadcast / TV Stereo System

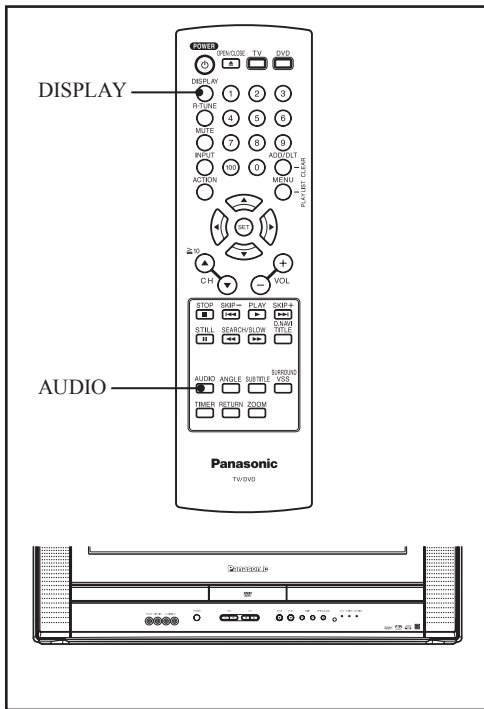

Receivable Broadcast Types

The following are possible audio broadcast types and on-screen displays. The signal being received is indicated with a “Ⓔ” mark while the selected audio mode is indicated with an arrow. To change the audio mode for these broadcasts, see the “Audio Mode for TV Viewing” section.

Press DISPLAY to display the broadcast signal being received.

MTS Stereo broadcast:

Multi-channel Television Sound Stereo broadcast. Select STEREO audio mode.

- If stereo broadcast is weak and the display flickers, select MONO audio mode for possible improvement.

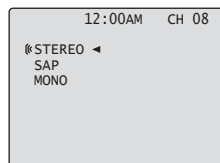

SAP broadcast:

Secondary Audio Program (sub language). Select SAP audio mode for the sub language.

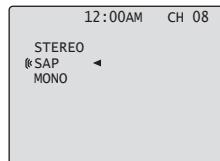

MTS Stereo and SAP broadcast:

Multi-channel Television Sound Stereo (main language) and Secondary Audio Program (sub language) broadcasts are being received simultaneously. Select the STEREO or SAP audio mode.

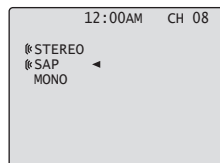

MONO broadcast:

Normal monaural sound broadcast.

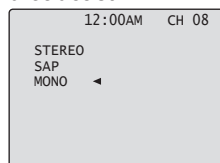

Equipped with **dbx**[®]-TV Noise Reduction for true MTS reproduction. **dbx**[®]-TV Noise Reduction is required for good stereo separation and audio fidelity. **dbx**[®] is a registered trademark, and is licensed by **dbx**[®] Technology Licensing.

Audio Mode for TV Viewing

Press AUDIO to select the desired audio mode as described above. (Arrow shows selection.)

- Each press of AUDIO will change the audio mode as shown below.
- “SAP” is selected with first press of AUDIO.

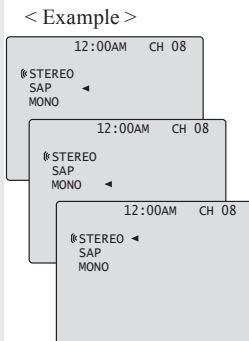

TV Timer Features

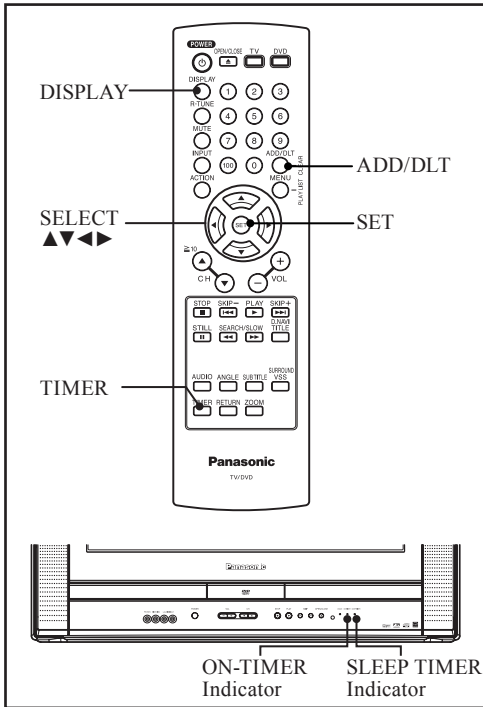

ON-TIMER

This unit can be set to automatically power on in one of 2 modes (TV or Disc.)

- 1 Press **TIMER** to display **SET TIMER** screen.
- 2 Press **▲▼** to select **"ON TIMER."**
- 3 Press **SET** to display **ON TIMER** screen.

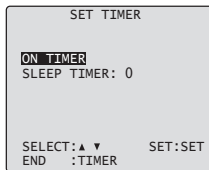

- 4 Press **▲▼** to select desired settings.
- 5 Press **SET** to set the ON-TIMER time and ON-TIMER mode.

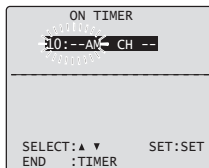

- Make sure a disc is inserted if Disc (DVD/CD) mode is selected.

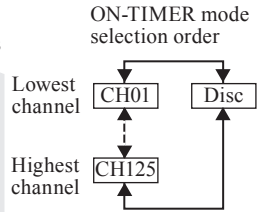

To Make Corrections, use **▲▼** and **◀▶** to move back and correct.

6 Press **TIMER** to set ON TIMER.

- "ON TIMER SET" is displayed.
- ON-TIMER Indicator lights up on the unit.

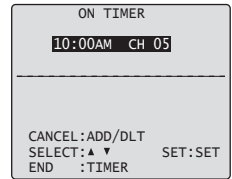

To Cancel ON-TIMER, Repeat steps 1-3. Then, press **ADD/HLT** to clear the time in steps 4-5. Now, press **TIMER** to end. "ON TIMER END" briefly appears on-screen.

Note

- If no button on the remote or unit is pressed within 60 minutes after unit turns itself on, it will turn itself back off.

Sleep Timer

This unit can be set for auto power off.

- 1 Press **TIMER** to display **SET TIMER** screen.
- 2 Press **▲▼** to select **"SLEEP TIMER."**
- 3 Press **SET** repeatedly to select the desired time.

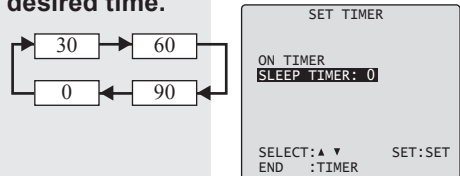

To cancel, press **SET** repeatedly until 0 appears.

4 Press **TIMER** to return to the normal screen.

- Pressing **DISPLAY** with sleep timer set displays remaining time.
- **SLEEP TIMER** Indicator lights up on the unit.

Closed Caption System

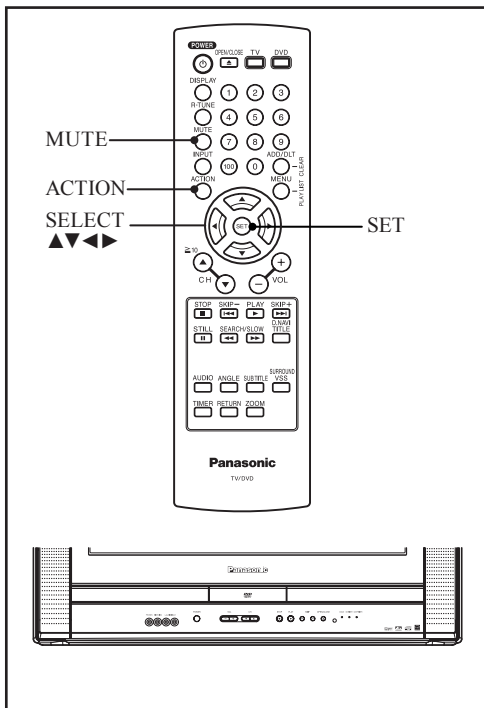

Closed Caption is ...

This multi-use system not only allows the hearing impaired to enjoy selected programs, but also allows one to watch programs with the volume muted.

Closed Caption Mode Feature

1 Press ACTION to display MAIN MENU.

2 Press ▲▼◀▶ to select "TV."

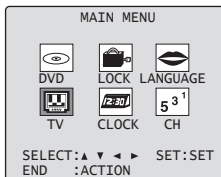

3 Press SET to display SET UP TV screen.

4 Press ▲▼ to select "CAPTION".

5 Press SET to display CAPTION screen.

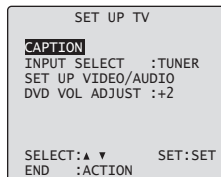

6 Press ▲▼ to select "CAPTION MODE."

7 Press SET repeatedly to select mode.

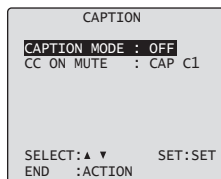

Caption Mode: CAP C1 or C2

A narration of selected TV programs is displayed. Check TV program listings for CC (Closed Caption) broadcasts.

Caption Mode: TEXT C1 or C2

Most of the screen will be blocked out. When the TV station broadcasts information, such as program listings, it will appear in this space.

Caption Mode: OFF

Closed Caption/Text narration will not be displayed.

8 Press ACTION three times to return to the normal screen.

Note

- The closed caption or text signal may be broadcast over C1, C2, or both. Also, text contents can vary so you may wish to try different settings.

Caption On Mute Feature

Closed Caption narration, if available, is displayed when MUTE button is pressed for silence.

- 1 Press **ACTION** to display **MAIN MENU**.
- 2 Press **▲▼◀▶** to select **“TV.”**
- 3 Press **SET** to display **SET UP TV** screen.

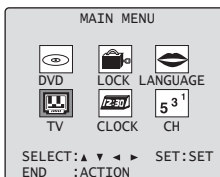

- 4 Press **▲▼** to select **“CAPTION”**.
- 5 Press **SET** to display **CAPTION** screen.

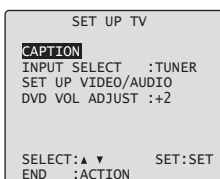

- 6 Press **▲▼** to select **“CAPTION MODE.”**
- 7 Press **SET** repeatedly to select **“OFF.”**

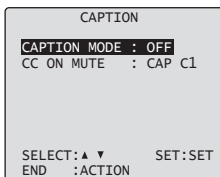

- 8 Press **▲▼** to select **“CC ON MUTE.”**
- 9 Press **SET** repeatedly to select **desired mode.**

- The caption may be broadcast over CAP C1 or C2.

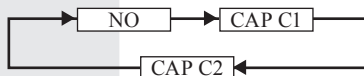
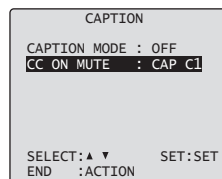

CC ON MUTE: CAP C1 or C2

A narration of selected TV programs is displayed when MUTE button is pressed for silence.

CC ON MUTE: NO

A narration will not be displayed when MUTE button is pressed for silence.

- 10 Press **ACTION** three times to return to the normal screen.

- 11 Press **MUTE** to mute the sound and display closed captioning.

- To cancel, press MUTE again.

Note

- When a disc supporting closed captions is used, the subtitle and the closed caption may overlap. In this case, turn the subtitle or caption mode off. (See page 42.)

Video / Audio Menu

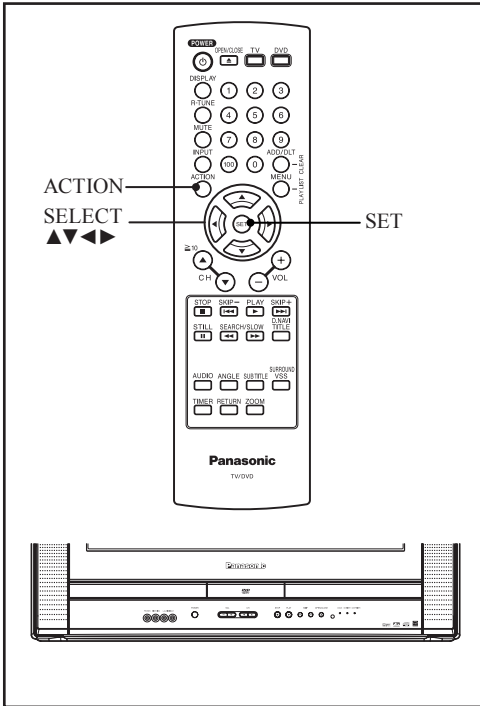

This feature allows easy setting of picture and sound suitable for each program source.

Video Menu

- 1 Press ACTION to display MAIN MENU.
- 2 Press $\blacktriangle\blacktriangledown\blacktriangleleft\blacktriangleright$ to select "TV."
- 3 Press SET to display SET UP TV screen.
- 4 Press $\blacktriangle\blacktriangledown$ to select "SET UP VIDEO/AUDIO."
- 5 Press SET to display.

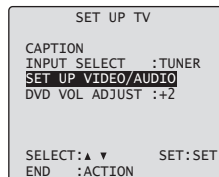
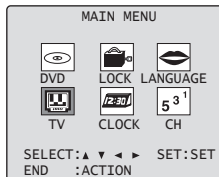

- 6 Press $\blacktriangle\blacktriangledown$ to select "VIDEO MENU."

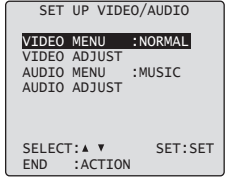

- 7 Press SET repeatedly to select desired mode.

NORMAL	Factory setting.
MOVIE	Picture is adjusted for a movie-like feel.
NIGHT	Color and picture intensity are adjusted to be easier on the eyes for night viewing.

- 8 Press ACTION three times to end setup.

Audio Menu

- 1 Do steps 1 - 5 at left.
- 2 Press $\blacktriangle\blacktriangledown$ to select "AUDIO MENU."
- 3 Press SET to select desired mode.

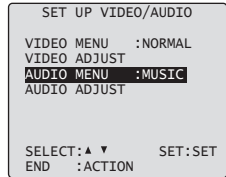

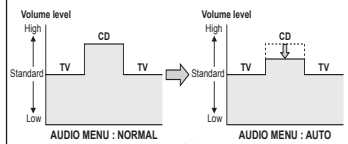
MUSIC	Sound suited to music. (Factory setting)
SPEECH	Sound suited to dialogue.
NORMAL	
AUTO	[Audio AGC (Auto Gain Control)] The sound level is automatically adjusted to suit the program source. 
MOVIE	Sound suited to movies.

- 4 Press ACTION three times to end setup.

Notes

- The effects of this feature on the signal are not output to the Audio/Video Output Connector.
- When AUDIO MENU mode is "AUTO," the AUDIO ADJUST setting will be "STANDARD."
- AUDIO MENU settings remain in memory.
- VIDEO MENU settings do not remain in memory.

Video Adjustment

Press ACTION to display MAIN MENU.

- 1 Press ▲▼◀▶ to select "TV."
- 2 Press SET to display SET UP TV screen.

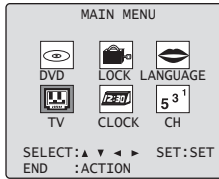

- 3 Press ▲▼ to select "SET UP VIDEO/AUDIO."
- 4 Press SET to display.

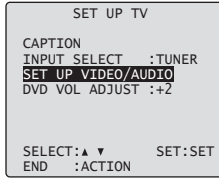

- 5 Press ▲▼ to select "VIDEO ADJUST."
- 6 Press SET to display.

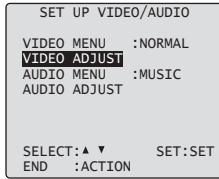

- 7 Press ▲▼ to select an item.
- 8 Press ▶◀ to adjust.

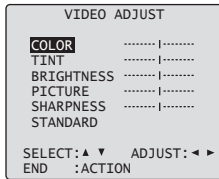

COLOR Control	Adjust color intensity.
TINT Control	Adjust for natural flesh tones.
BRIGHTNESS Control	Adjust picture brightness.
PICTURE Control	Adjust picture intensity by adjusting both contrast and color level in the proper balance.
SHARPNESS Control	Increases or decreases the level of detail in the image.

To Reset VIDEO Controls.

Press ▲▼ and SET to select and set "STANDARD." All controls return to their factory settings.

- 9 Press ACTION four times to end setup.

Audio Adjustment

Press ACTION to display MAIN MENU.

- 1 Press ▲▼◀▶ to select "TV."
- 2 Press SET to display SET UP TV screen.

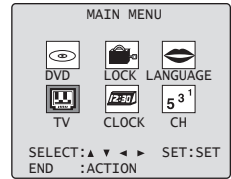

- 3 Press ▲▼ to select "SET UP VIDEO/AUDIO."
- 4 Press SET to display.

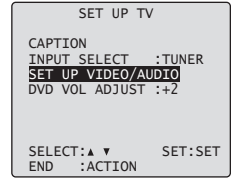

- 5 Press ▲▼ to select "AUDIO ADJUST."
- 6 Press SET to display.

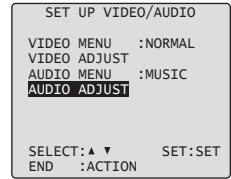

- 7 Press ▲▼ to select an item.
- 8 Press ▶◀ to adjust.



BASS Control	To adjust the intensity of low frequency sound.
TREBLE Control	To adjust the intensity of high frequency sound.
BALANCE Control	Controls the difference in audio level between the left and right speaker.

- The levels set here do not affect other audio equipment when connected to the Audio Output L/R Connector.

To Reset AUDIO Controls.

Press ▲▼ and SET to select and set "STANDARD." All controls return to their factory settings.

- 9 Press ACTION four times to end setup.

Weak Signal Display Feature

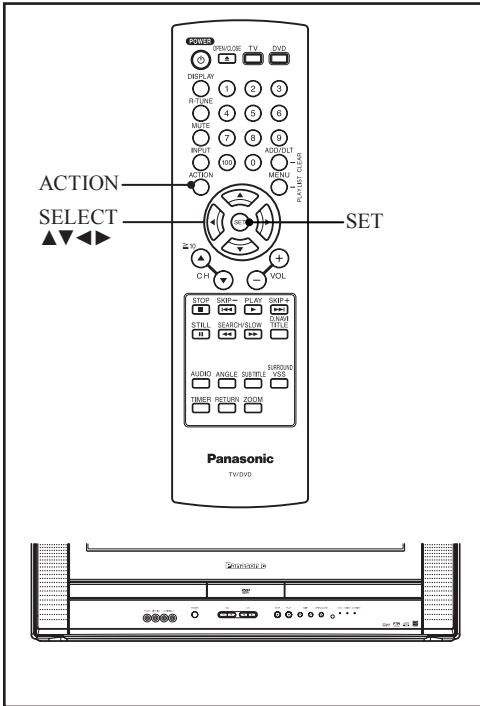

When “ON” is selected, the picture is displayed even when a broadcast signal is weak or non-existent.

- 1 Press **ACTION** to display **MAIN MENU**.
- 2 Press **▲▼◀▶** to select “CH.”
- 3 Press **SET** to display **SET UP CHANNEL** screen.

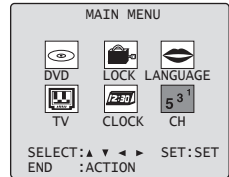

- 4 Press **▲▼** to select “**WEAK SIGNAL DISPLAY.**”
- 5 Press **SET** to set “**ON**” or “**OFF.**”

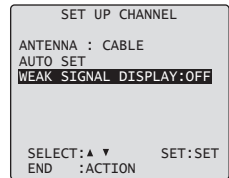

ON:

Picture is displayed regardless of signal condition, and may not always be clearly visible.

OFF:

Screen turns solid blue when signal is absent or weak.

Note

- If unit is connected to equipment which has blue back feature, selecting “ON” will have no effect on the other equipment.

- 6 Press **ACTION** twice to return to the normal screen.

V-Chip Control Features

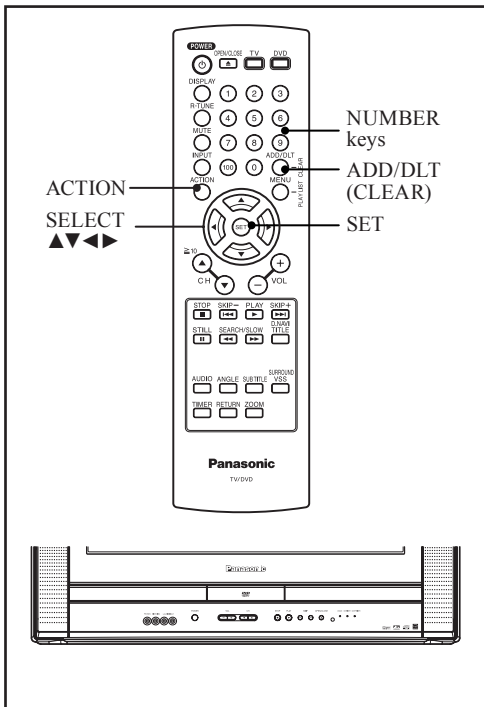

4 Press NUMBER keys to enter your secret code.

- Take care that you are not observed entering the secret code.

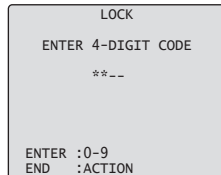

5 Enter same code again for confirmation.

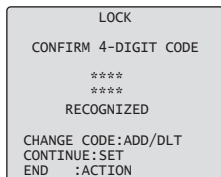

■ To Make Corrections

- Press ◀ repeatedly to move the cursor.
- Press NUMBER keys to make the correction.

6 Press SET to display Ratings menu (see pages 32-36). Or press ACTION twice to exit.

Notes

- Some rental movies do not include V-Chip data.
- Do not forget your secret code.
- Once ratings are set, restricted tapes or programs cannot be accessed unless the secret code is entered.
- Step 5 not necessary when changing rating.

V-Chip Control Feature is...

This unit has a built-in V-Chip Control which allows you to block unwanted TV usage based on US MOVIES, US TV PROGRAMS Ratings, Canadian English Language Ratings and Canadian French Language Ratings.

Enter Secret Code

A 4-digit code must be entered to view a blocked program or change rating settings.

- Press ACTION to display MAIN MENU.
- Press ▲▼◀▶ to select "LOCK."
- Press SET to display LOCK screen.

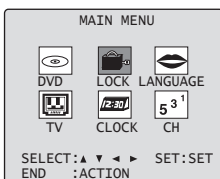

Changing your secret code

You will need your current code.

- While this OSD (on screen display) is displayed, press ADD/DEL (CLEAR) to clear current code.

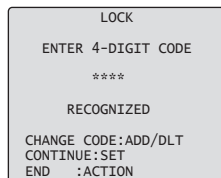

- Enter new secret code.

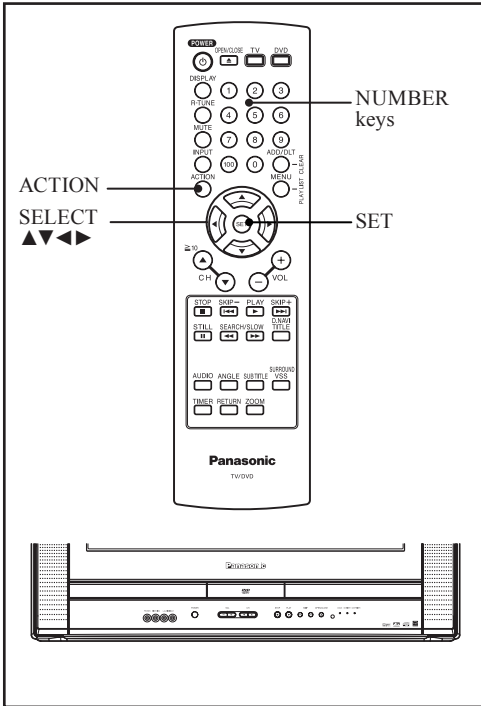

If LOCK menu is not displayed, perform “Enter Secret Code” steps on page 31.

US MOVIES Ratings

1 Press ▲▼ to select “US MOVIES.”

- “NEXT PAGE” displays CANADIAN V-Chip settings menu. Please refer to pages 34-35 for more details on Canadian tapes or broadcasts.

2 Press SET to set “ON” or “OFF.”

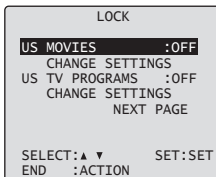

ON:

V-Chip Control is activated.

OFF:

V-Chip Control is deactivated.

3 Press ▲▼ to select “CHANGE SETTINGS.”

4 Press SET to display screen.

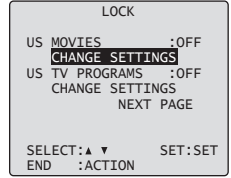

5 Press ▲▼ to select “VIEW NR PROGRAMS?”

6 Press SET to set “YES” or “NO.”

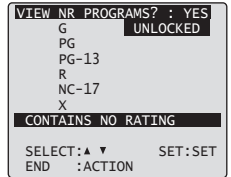

NR (Not Rated) PROGRAMS:

Some movies, such as old movies or foreign movies have no ratings.

7 Press ▲▼ to select and SET to set ratings to be blocked.

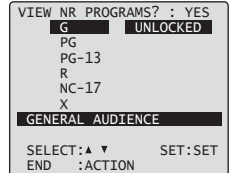

G	GENERAL AUDIENCE: All ages admitted.
PG	PARENTAL GUIDANCE: Some material may not be suitable for children.
PG-13	PARENTS CAUTIONED: Some material may be inappropriate for children under 13.
R	RESTRICTED: Children under 17 must be accompanied by a parent or adult.
NC-17	OVER AGE 17 ONLY: No one 17 and under admitted.
X	ADULTS ONLY:

8 Press ACTION to redisplay LOCK menu and continue with US TV PROGRAMS Ratings (page 33). Or, press ACTION three times to exit.

US TV PROGRAMS Ratings

1 Press ▲▼ to select “US TV PROGRAMS.”

- “NEXT PAGE” displays CANADIAN V-Chip setting menu. Please refer to pages 34-35 for more details on Canadian tapes or broadcasts.

2 Press SET to set “ON” or “OFF.”

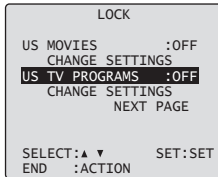

ON:

V-Chip Control is activated.

OFF:

V-Chip Control is deactivated.

3 Press ▲▼ to select “CHANGE SETTINGS.”

4 Press SET to display screen.

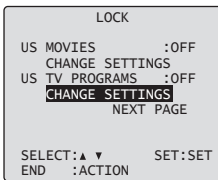

5 Press ▲▼ to select “VIEW NR PROGRAMS?”

6 Press SET to set “YES” or “NO.”

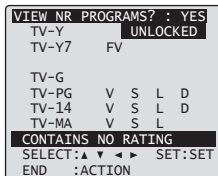

NR (Not Rated) PROGRAMS:

Some TV shows, such as news, sports, weather, bulletins, emergency information have no ratings.

7 Press ▲▼ to select and SET to set ratings to be blocked.

- You may select from standard TV ratings (chart 1), or customize to a specific content rating (chart 2).
- Ratings highlighted in green will be blocked. Ratings in white letters will not be blocked.

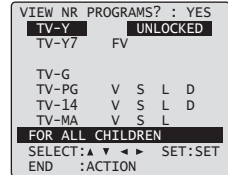

Chart 1

TV-Y	FOR ALL CHILDREN: Content specifically geared to young viewers ages 2-6.
TV-Y7	FOR AGE 7 AND OLDER: May contain mild physical or comedic violence which may frighten children under 7.
TV-G	GENERAL AUDIENCE: Contains little or no violence, strong language, or sexual dialogue or situations.
TV-PG	PARENTAL GUIDANCE: May contain infrequent coarse language, limited violence, some suggestive sexual dialogue and situations.
TV-14	PARENTS CAUTIONED: May contain sophisticated themes, sexual situations, strong language, and more intense violence.
TV-MA	MATURE AUDIENCE: May contain mature themes, profane language, graphic violence, and sexual situations.

Chart 2

FV	Fantasy Violence
V	Violence
S	Sexual Situations
L	Adult Language
D	Sexually Suggestive Dialogue

8 Press ACTION three times to exit this mode.

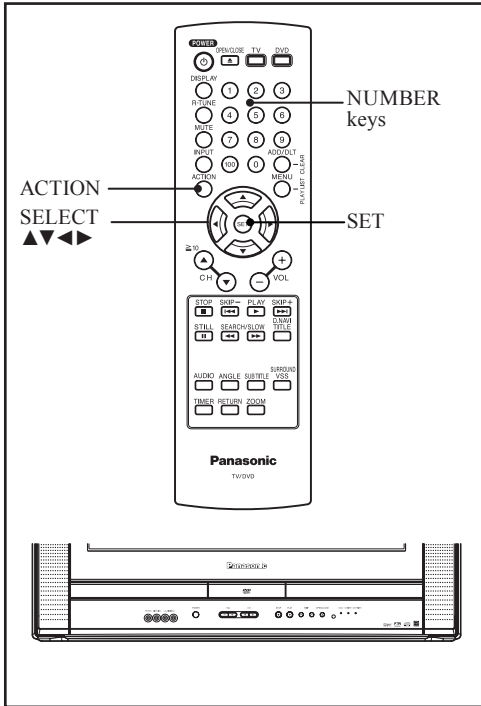

If LOCK menu is not displayed, perform “Enter Secret Code” steps on page 31.

Canadian English Language Ratings

- 1 Press ▲▼ to select “NEXT PAGE.”
- 2 Press SET to display screen.
- 3 Press ▲▼ to select “CANADIAN ENGLISH.”
- 4 Press SET to set “ON” or “OFF.”

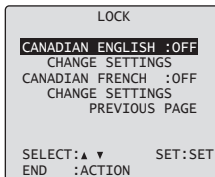
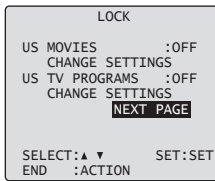

ON:
V-Chip Control is activated.
OFF:
V-Chip Control is deactivated.

- 5 Press ▲▼ to select “CHANGE SETTINGS.”
- 6 Press SET to display screen.
- 7 Press ▲▼ to select “VIEW E PROGRAMS?.”
- 8 Press SET to set “YES” or “NO.”

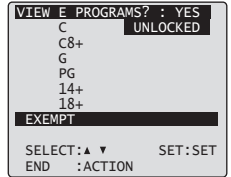
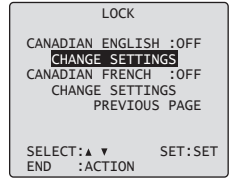

E (Exempt) PROGRAMS:
Some TV shows, such as news, sports, weather, bulletins, and emergency information have no ratings.

- 9 Press ▲▼ to select and SET to set ratings to be blocked.

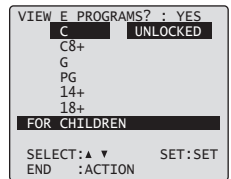

C	Children
C8+	Children 8 years and older
G	General Audience
PG	Parental Guidance
14+	Viewers 14 years and older
18+	Adult Programming

- 10 Press ACTION to redisplay LOCK menu and continue with Canadian French Language Ratings (next page). Or, press ACTION three times to exit.

Canadian French Language Ratings

- 1 Press ▲▼ to select “NEXT PAGE.”
- 2 Press SET to display screen.

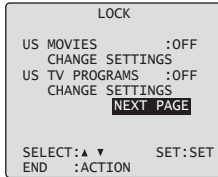

- 3 Press ▲▼ to select “CANADIAN FRENCH.”
- 4 Press SET to set “ON” or “OFF.”

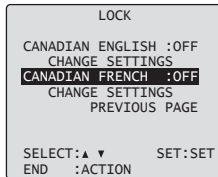

ON:
V-Chip Control is activated.

OFF:
V-Chip Control is deactivated.

- 5 Press ▲▼ to select “CHANGE SETTINGS.”
- 6 Press SET to display screen.

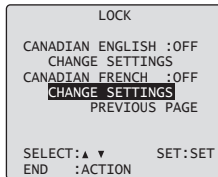

- 7 Press ▲▼ to select “VIEW E PROGRAMS?.”
- 8 Press SET to set “YES” or “NO.”

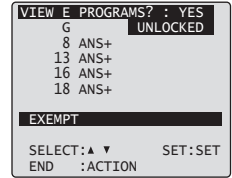

E (Exempt) PROGRAMS:

Some TV shows, such as news, sports, weather, bulletins, and emergency information have no ratings.

- 9 Repeatedly press ▲▼ to select and SET to set ratings to be blocked.

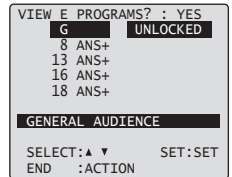

G	General Audience
8 ANS +	Not recommended for young children
13 ANS +	Programming may not be suitable for children under the age of 13
16 ANS +	Programming is not suitable for children under the age of 16
18 ANS +	Programming restricted to adults

- 10 Press ACTION three times to exit this mode.

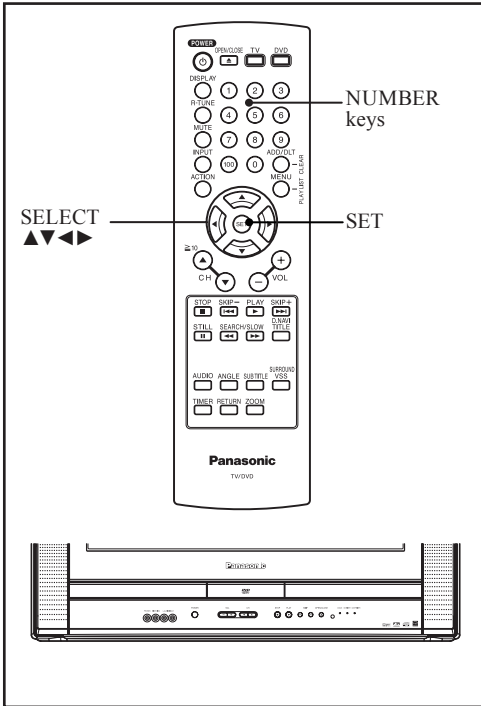

Blocking Message

<When V-Chip Control is activated>

If a program or movie exceeds the ratings you have set, a message will appear on a black background and sound is muted.

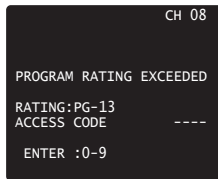

<US Rating>

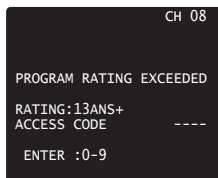

<Canadian French Rating>

To View a Blocked Program/Movie

■ Temporarily Deactivate V-Chip Control

Press NUMBER keys to enter your secret code in the Blocking Message screen.

- V-Chip Control is reactivated when power is turned off or power failure occurs.

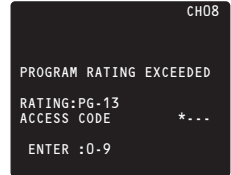

<Example: US Rating>

■ Deactivate V-Chip Control

1 Enter your secret code. (See page 31.)

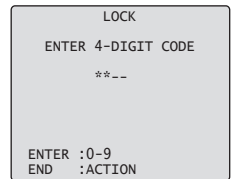

2 Then, set US MOVIES and/or US TV PROGRAMS and/or CANADIAN ENGLISH LANGUAGE and/or CANADIAN FRENCH LANGUAGE to "OFF" using ▲▼ and SET. (Ratings set on pages 31-35 are retained and will be in effect when V-Chip Control is activated again.)

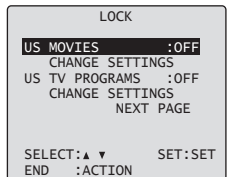

<US Rating>

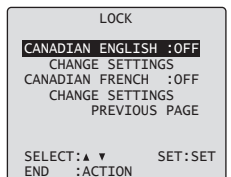

<Canadian Rating>

Display Feature

TV Status & Clock Display

Press DISPLAY

to display or remove the overlay.

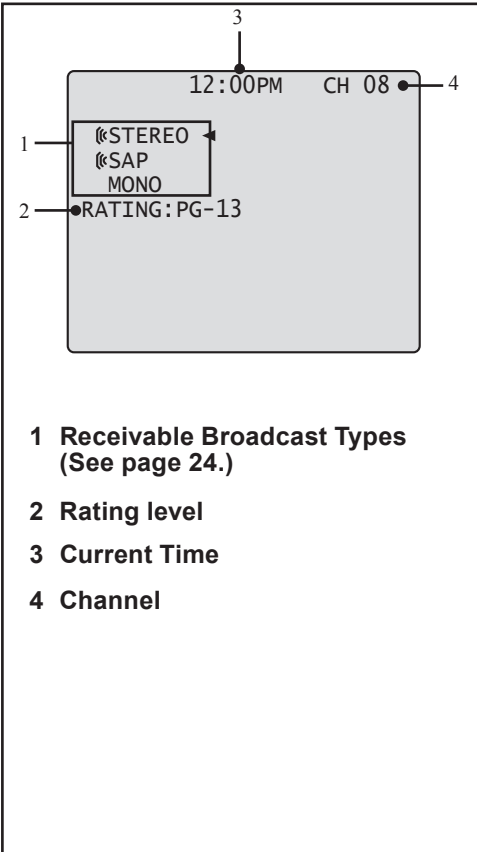

- 1 Receivable Broadcast Types (See page 24.)
- 2 Rating level
- 3 Current Time
- 4 Channel

Channel Display

When you change channels, channel number will be displayed.

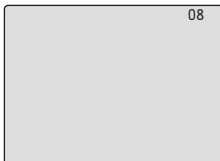

Auto Shut Off

No broadcast signal in TV mode (Only when Weak Signal Display is set to OFF. (see page 30)).

Power turns off.

Note

- This feature is canceled if any button is pressed during above conditions.

Blue Screen Display

When the selected channel has no broadcast signal with the Weak Signal Display Feature set to "OFF" (see page 30), the screen will turn solid blue.

Basic Disc Operation

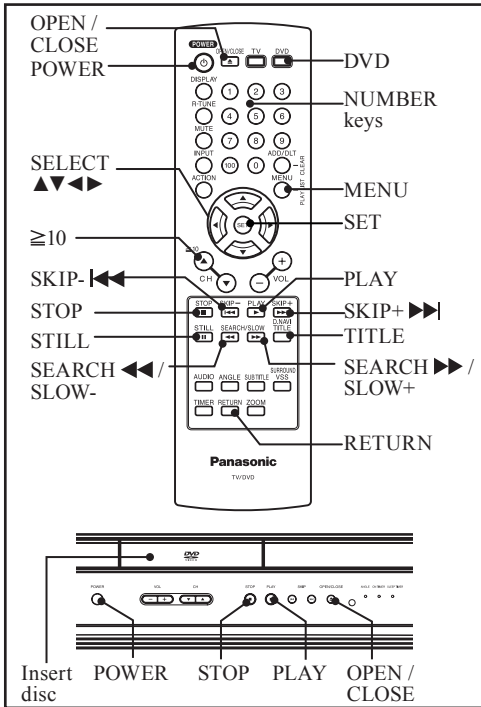

5 Press PLAY to start play. Disc tray closes automatically.

- You may also close the tray by pressing OPEN/CLOSE.
- Data reading time differs with each disc.

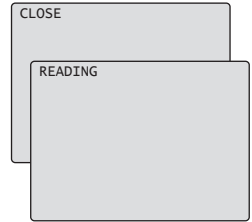

If an interactive DVD is used and a Main MENU of DVD appears, go to step 6.

<Example>

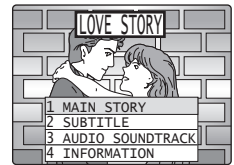

While Main MENU is displayed, Press SKIP+ >>> or SKIP- <<< to go to next or previous Main MENU of DVD screen.

- SKIP function not available with all discs. Please refer to disc jacket for operation information.

6 Press ▲▼◀▶ to select title and press SET to start play. Or, pressing NUMBER keys starts play automatically.

- The number of available titles varies with each disc.

To return to Main MENU of DVD (play stops): Press TITLE, MENU, or RETURN.

7 Press STOP to stop playing.

8 Press OPEN/CLOSE to eject the disc.

If a remote control button does not work when pressed, press the DVD button on the remote and try the button again.

Play Disc

- 1 Press POWER on the remote or unit.
- 2 Press DVD to set remote to DVD mode.
- 3 Press OPEN/CLOSE.
 - If a disc is already inserted, go to step 5. (Depending on the disc, playback may start automatically.)
- 4 Place disc into disc tray.
 - Hold disc by its edges only (page 10) with printed side up and use guides to place into tray. Use ① 3" (8 cm) or ② 5" (12 cm) disc.

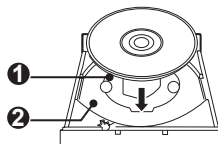

Auto-Power Off function

DVD-V CD DVD-RAM

Power turns off after unit is in stop mode with wallpaper displayed for about 5 minutes.

- When \odot appears on the screen while a button is being pressed, it means that the corresponding operation is prohibited by the unit or the disc.

Using the NUMBER keys

DVD-V CD DVD-RAM

When a NUMBER key is used in disc mode, it performs a different operation from TV mode.

Example 1:

To select 12, first press the ≥ 10 key, then 1, then 2.

Example 2:

To select 2, press the 2 key.

Forward/Reverse Rapid Scene Search

DVD-V CD DVD-RAM

1 Press SEARCH \gg /SLOW+ or SEARCH \ll /SLOW- during play.

- Search speed, slow at first, increases with each additional press of the button up to 5 levels.

2 Press PLAY to release.

Forward/Reverse Chapter/Track Skip

DVD-V CD DVD-RAM

1 Press SKIP+ \gg | or SKIP- | \ll during play.

DVD and CD

- Pressing SKIP- | \ll once midway through a chapter/track returns to start of that chapter/track. Each additional press skips back one chapter/track.

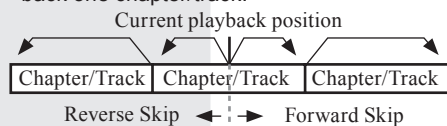

DVD-RAM

- Pressing SKIP- | \ll once midway through a program/play list returns to start of that program/play list. Each additional press skips back one program/play list.

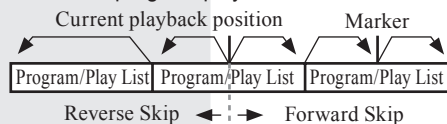

2 Each press skips a chapter (DVD), track (CD) or Program/Play List/Marker (DVD-RAM).

- Pressing SKIP within 3 seconds of a track/chapter/program/play list start point skips to the previous start point.

Still (Pause) Picture

DVD-V CD DVD-RAM

1 Press STILL during play.

- DVD:
The unit will enter Still picture mode.
- CD:
The unit will enter Pause mode.

2 Press PLAY to release.

Frame by Frame Picture

DVD-V DVD-RAM

1 Press STILL in Still mode.

- Each press advances picture one frame.
- Hold down for consecutive frame advance.

2 Press PLAY to release.

Note

- Whether pictures are advanced by "FRAME" or "FIELD" is selected automatically (see page 57).

Slow Motion Picture

DVD-V DVD-RAM

1 Press SEARCH \gg /SLOW+ or SEARCH \ll /SLOW- in Still mode.

- Slow motion speed, slow at first, is increased with each additional press of the button up to 5 levels.

2 Press PLAY to release.

RESUME Function

DVD-V CD DVD-RAM

The unit memorizes the point where STOP is pressed (STOP \blacktriangleright display on screen). Press PLAY to resume play from this point. Pressing STOP again in DVD mode or opening the tray cancels RESUME. However, RESUME is not canceled when power is turned off and on.

Notes

- RESUME works only with discs for which elapsed play time is displayed during play.
- When a DVD-RAM still picture is played back, the counter will not be displayed, however, RESUME will function.

Disc Operation -In PLAY mode-

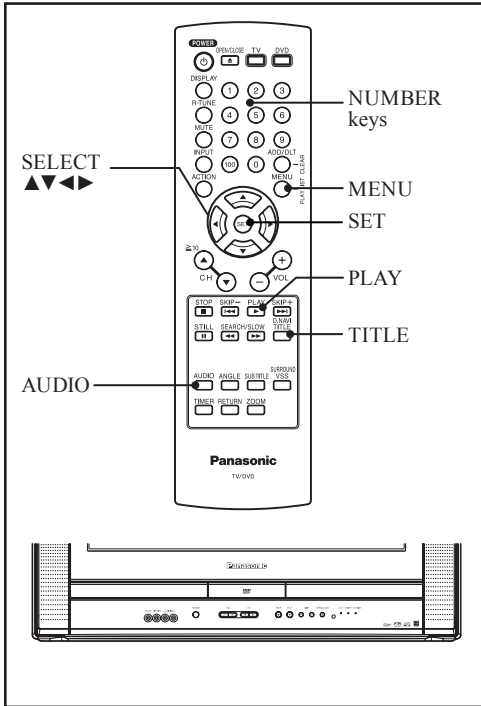

3 Press SET or PLAY to access.

- Step 3 not necessary when using NUMBER keys.

Note

- Repeat steps 2-3 if there is more than one menu.

Title Menu of DVD

DVD-V

Some DVDs offer more than one title, e.g. movies. If the disc offers a title menu, you can select the desired title number. (Operation may vary according to the disc.)

1 Press TITLE in Play mode to display title screen.

<Example>

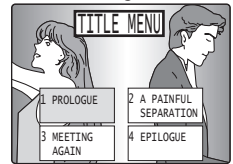

2 Press ▲▼◀▶ or NUMBER keys to select a title.

3 Press SET or PLAY to access.

- Step 3 not necessary when using NUMBER keys.

<Example>

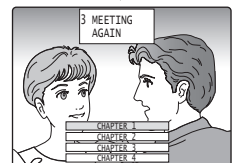
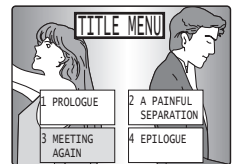

Main Menu of DVD

DVD-V

DVDs may offer a special menu. This menu may include guides to unique contents, audio/subtitle languages, etc. Although contents and operation may vary, the following steps show basic steps for using menus.

1 Press MENU in Play mode to display main menu of DVD.

2 Press ▲▼◀▶ or NUMBER keys to select an item.

<Example>

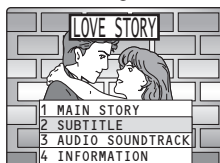

- When  appears on the screen while a button is being pressed, it means that the corresponding operation is prohibited by the unit or the disc.

Audio Soundtrack Language

DVD-V

You can change the audio soundtrack language, selected at Settings for DVD Operation, to a different language if available. (See page 54.)
(This operation works only with discs on which multiple audio soundtrack languages are recorded.)

1 Press AUDIO in Play mode to display the audio selection on-screen.

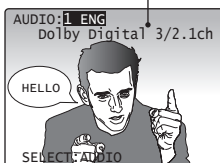

- Display disappears after 5 seconds.

Information on the audio stream currently being played back is displayed. (See page 56.)



LPCM	96 kHz	16 bit	Linear PCM disc
	or	20 bit	
	48 kHz	24 bit	
Dolby Digital	1 ch - 5.1 ch	Dolby Digital disc	
dts	1 ch - 5.1 ch	dts disc	

Note

- With DVD-RAM, Audio Soundtrack Language cannot be set. Audio stream and Audio mode (LR/L/R) settings can be made. Audio stream operation method is the same as for Audio Soundtrack Language. Press  to move the cursor to Audio mode, then press AUDIO or  to select LR/ L/ R.

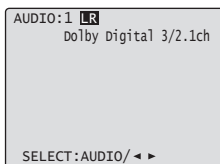

2 Press AUDIO, , or NUMBER keys to select desired language.

Audio soundtrack language being played back.



ENG	English	POR	Portuguese
FRA	French	RUS	Russian
DEU	German	JPN	Japanese
ITA	Italian	CHI	Chinese
ESP	Spanish	KOR	Korean
NLD	Dutch	MAL	Malay
SVE	Swedish	VIE	Vietnamese
NOR	Norwegian	THA	Thai
DAN	Danish	*	Other

Notes

- If, after several presses of the AUDIO button, the language does not change, language selection is not offered on the disc.
- When disc is removed, language reverts to initial setting. If this language is not recorded on the disc, the language recorded will be heard.

Vocal selection for Karaoke discs

DVD-V

1 Press AUDIO in Play mode to display the audio screen.

2 Press to select "VOCAL."

3 Press AUDIO or to set.

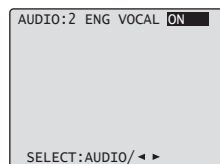

DVD Karaoke (1 vocal)

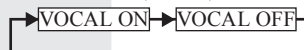

DVD Karaoke (2 vocals)

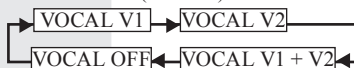

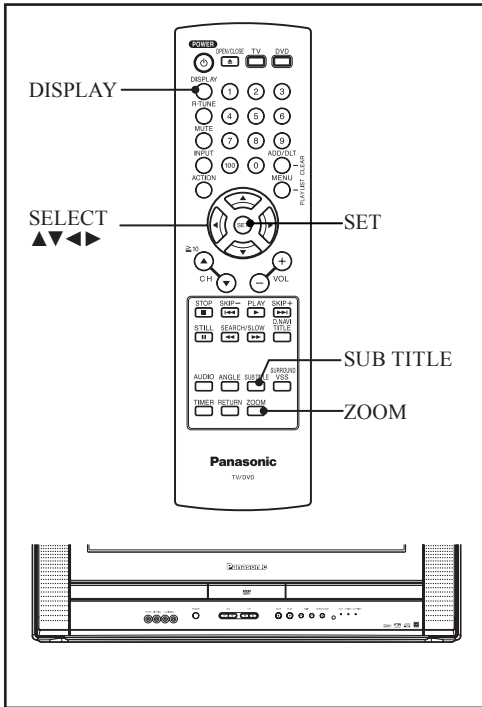

2 Press SUB TITLE, ▲▼, or NUMBER keys to select desired language.

Note

- With DVD-RAM, the subtitle can only be set to ON/OFF. The subtitle language cannot be selected.

Number of subtitle language being played back.



ENG	English	POR	Portuguese
FRA	French	RUS	Russian
DEU	German	JPN	Japanese
ITA	Italian	CHI	Chinese
ESP	Spanish	KOR	Korean
NLD	Dutch	MAL	Malay
SVE	Swedish	VIE	Vietnamese
NOR	Norwegian	THA	Thai
DAN	Danish	*	Other

Subtitle Language

DVD-V **DVD-RAM**

You can select a different subtitle language (if offered) than the one set at Settings for DVD Operation. (See page 54.)

1 Press SUB TITLE in Play mode to display the subtitle selection on-screen.

- Display disappears after 5 seconds.
- When no subtitles are offered, “-” will be displayed instead of the language number.



Notes

- When closed captioning is used along with subtitles, they may overlap. If so, turn one function off. (See pages 26-27.)
- If, after several presses of the button, the language does not change, language selection is not offered on the disc.
- Subtitles may not change to the selected language immediately.
- When disc is removed, subtitles revert to initial setting language. If the initial language is not recorded on the disc, the disc's priority language will appear.

• When  appears on the screen while a button is being pressed, it means that the corresponding operation is prohibited by the unit or the disc.

Information Display

DVD-V CD DVD-RAM

When DISPLAY is pressed, On-Screen Displays show disc information and unit information.

Press DISPLAY in Play or Stop mode to display “On-Screen Display.”

- Each press of DISPLAY changes the on-screen display as follows. (Please refer to pages 46-49.)

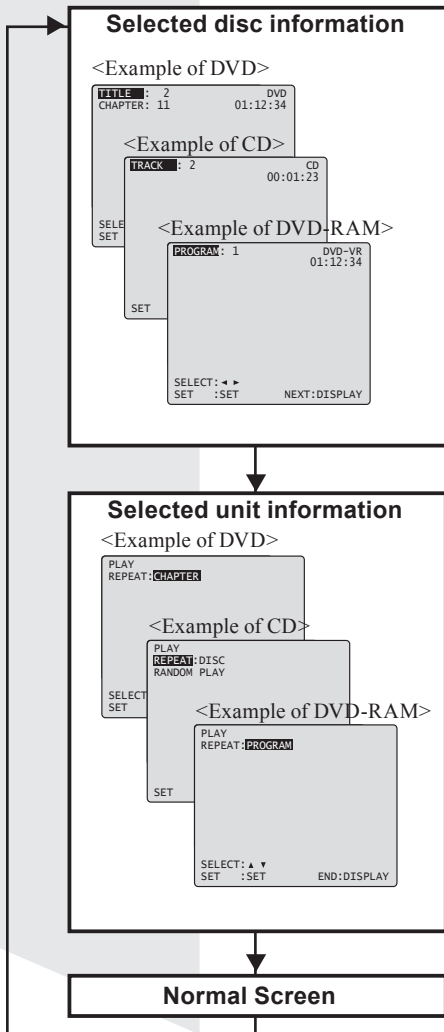

Note

- DISPLAY button does not function while main menu of DVD, title menu of DVD, Direct Navigator, or Play List is displayed.

Picture Zoom

DVD-V DVD-RAM

You can enlarge specific portions of a picture and select the zoom ratio using the ZOOM button on the remote during DVD playback.

1 Press ZOOM repeatedly to change display as follows.

- You can enlarge the center portion of the image to one of 2 magnifications.

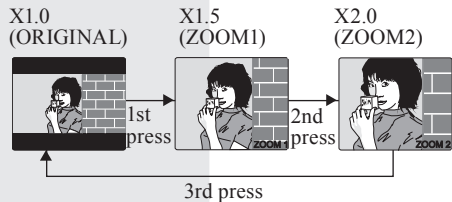

2 Use the ▲, ▼, ◀ and ▶ buttons to move the position up, down, left and right.



Notes

- The subtitle cannot be enlarged nor can its position be changed.
- During picture zoom, “ZOOM1” or “ZOOM2” appears on-screen for 5 seconds.
- Zooming, on some discs, may result in poor picture quality, or may not operate at all.

DVD-RAM Operation

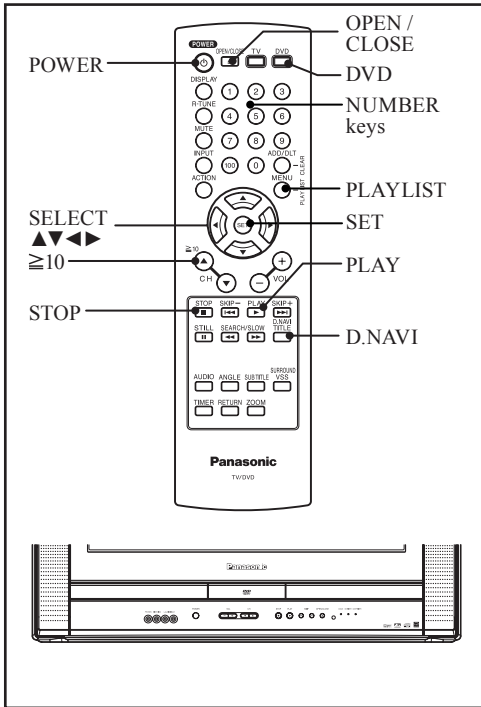

You can enjoy playing your personally recorded/edited DVD-RAM discs on this unit.

Note

- This unit was designed for playback only. DVD-RAM recording is not possible.

Play a DVD-RAM

DVD-RAM

- Press **POWER** on the remote or unit.
- Press **DVD** to set remote to DVD mode.
- Press **OPEN/CLOSE**.
- Place disc into disc tray.
- Press **PLAY** to start play. Disc tray closes automatically.
 - Play begins from the first program title recorded on the DVD-RAM.

6 Press **PLAYLIST** or **D.NAVI** to display Play List or Direct Navigator menu for easy title or scene selection.

Example: Play List menu

Play List No. Recorded time length Page No.

Play List		Page1/5	
No.	Date	Length	Title
1	2002/12/24 5:15:41AM	00:01:00	Movie Picture Playback
2	2002/12/23 4:31:49AM	00:03:12	Still Picture Playback
3	2002/12/23 8:24:25AM	00:15:01	Hybrid Playback
4	2002/12/23 12:45:00AM	00:03:00	Partial Playback

Recording time and date Titles

SELECT: ▲ ▼ ◀ ▶ END: MENU

Example: Direct Navigator menu

Program No. Recorded time length Page No.

Direct Navigator		Page1/4	
No.	Date	Length	Title
1	2002/12/24 5:15:41AM	01:00:00	Drama
2	2002/12/25 4:31:49AM	00:30:00	Pana NEWS
3	2002/12/25 8:24:25AM	01:30:25	Tigers vs. Giants
4	2002/12/25 12:45:00AM	02:00:50	Dinosaur

Recording time and date Titles

SELECT: ▲ ▼ ◀ ▶ END: TITLE

7 Press **STOP** to stop playing.

8 Press **OPEN/CLOSE** to eject the disc.

Notes

- Titles of Direct Navigator and Play List cannot be changed using this unit.
- With Direct Navigator, up to 99 programs can be displayed. With Play List, up to 99 titles (999 scenes) can be displayed.
- While DVD MAIN MENU is displayed, Play List and Direct Navigator display will not appear even if **PLAYLIST** or **D.NAVI** is pressed.

- When  appears on the screen while a button is being pressed, it means that the corresponding operation is prohibited by the unit or the disc.

Play List

DVD-RAM

If the DVD-RAM features a Play List, your preselected list of favorite scenes is displayed for easy access. (Operation can vary according to how you edited the DVD-RAM.)

- Press **PLAYLIST** in Play/Stop mode to display the Play List menu.

Play List		Page1/5	
No.	Date	Length	Title
1	2002/12/24 5:15:41AM	00:01:00	Movie Picture Playback
2	2002/12/25 4:31:49AM	00:03:12	Still Picture Playback
3	2002/12/25 8:24:25AM	00:15:01	Hybrid Playback
4	2002/12/25 12:45:00AM	00:03:00	Partial Playback
SELECT: ▲ ▼ ◀ ▶			
SET :SET		END:MENU	

- Press **◀▶** to select a page and press **▲▼** or the **NUMBER** keys to select a title (Play List No.).

Play List		Page1/5	
No.	Date	Length	Title
1	2002/12/24 5:15:41AM	00:01:00	Movie Picture Playback
2	2002/12/25 4:31:49AM	00:03:12	Still Picture Playback
3	2002/12/25 8:24:25AM	00:15:01	Hybrid Playback
4	2002/12/25 12:45:00AM	00:03:00	Partial Playback
SELECT: ▲ ▼ ◀ ▶			
SET :SET		END:MENU	

- Press **SET** or **PLAY** to start playing.

- Pressing SET or PLAY is not necessary when using NUMBER keys.

Using NUMBER keys starts play automatically.

- The number of available titles varies with each disc.

Example 1:

To select No. 12, first press the ≥ 10 key, then 1, then 2.

Example 2:

To select No. 2, press 2.

- Press **PLAYLIST** to clear Play List menu.

Direct Navigator

DVD-RAM

If the DVD-RAM features Direct Navigator, a list of recorded titles is displayed. Simply select a title number and start playback. (Operation can vary with disc used.)

- Press **D.NAVI** in Play/Stop mode to display the Direct Navigator menu.

Direct Navigator		Page1/4	
No.	Date	Length	Title
1	2002/12/24 5:15:41AM	01:00:00	Drama
2	2002/12/25 4:31:49AM	00:30:00	Pana News
3	2002/12/25 8:24:25AM	01:30:25	Tigers vs. Giants
4	2002/12/25 12:45:00AM	02:00:50	Dinosaur
SELECT: ▲ ▼ ◀ ▶			
SET :SET		END:TITLE	

- Press **◀▶** to select a page and press **▲▼** or the **NUMBER** keys to select a title (Program No.).

Direct Navigator		Page1/4	
No.	Date	Length	Title
1	2002/12/24 5:15:41AM	01:00:00	Drama
2	2002/12/25 4:31:49AM	00:30:00	Pana News
3	2002/12/25 8:24:25AM	01:30:25	Tigers vs. Giants
4	2002/12/25 12:45:00AM	02:00:50	Dinosaur
SELECT: ▲ ▼ ◀ ▶			
SET :SET		END:TITLE	

- Press **SET** or **PLAY** to start playing.

- Pressing SET or PLAY is not necessary when using NUMBER keys.

Using NUMBER keys starts play automatically.

- The number of available titles varies with each disc.

Example 1:

To select No. 12, first press the ≥ 10 key, then 1, then 2.

Example 2:

To select No. 2, press 2.

- Press **D.NAVI** to clear Direct navigator menu.

Disc Operation -Using Information Screen-

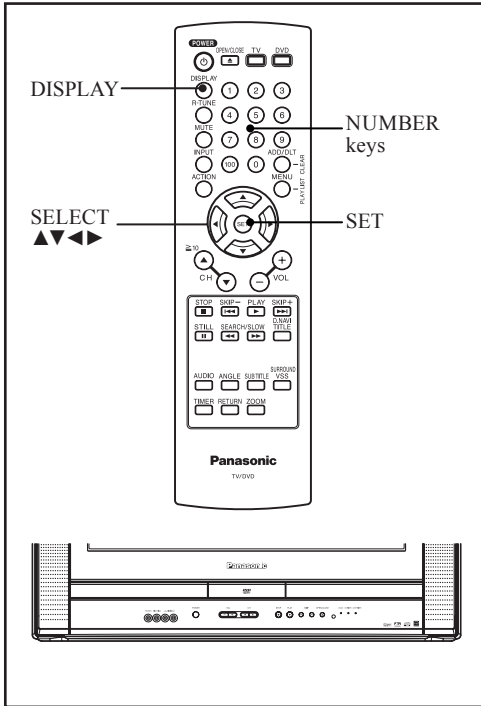

a.TITLE:

Go directly to a preset title number.

b.Chapter:

Go directly to a preset chapter number.
 • This function does not work with some discs.

c.Disc currently being played:

The type of disc currently inserted is displayed.

d.Elapsed playing time:

Go to a different scene by entering an elapsed playing time, then SET.
 • This function does not work with some discs.
 • If SET is pressed while making entries, unit returns to the condition before entries were made.

Example:

12 : 34 : 56 1 → 2 → 3 → 4 → 5 → 6
 00 : 20 : 00 2 → 0 → 0 → 0 → SET

Disc information screen 1

DVD-V

- 1 Press DISPLAY in Play or Stop mode to display "On-Screen Display."
- 2 Press ▲▼◀▶ to select an item.
- 3 Press SET to enter selected item. Cursor moves to the right. Change the item by pressing ▲▼ or the NUMBER keys, and press SET.

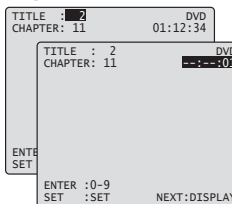
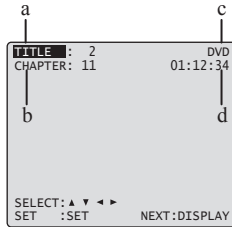

Unit information screen 1

DVD-V

- 1 Press DISPLAY twice in Play or Stop mode to display "On-Screen Display."
- 2 Press SET to enter. Cursor moves to the right. Change the item by pressing ▲▼ and press SET.

a.OPERATING MODE:

The current operation is displayed.

b.REPEAT MODE: REPEAT MODE can be selected

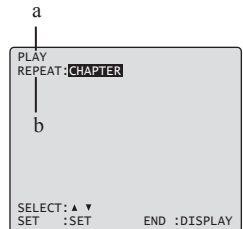

Example: CURRENT PLAYBACK POSITION

	TITLE		
	chapter	chapter	chapter
REPEAT:CHAPTER	→	→	→
REPEAT:TITLE	→	→	→
REPEAT:OFF	→	→	→

- When  appears on the screen while a button is being pressed, it means that the corresponding operation is prohibited by the unit or the disc.

Disc information screen 2

CD

- 1 Press **DISPLAY** in Play or Stop mode to display “On-Screen Display.”

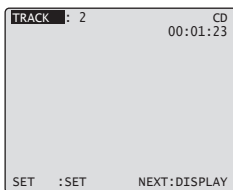

- 2 Press **SET** to enter selected item. Cursor moves to the right. Change the item by pressing **▲▼** or the **NUMBER** keys, and press **SET**.

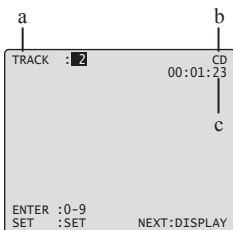

a.TRACK:

Go directly to a preset track number.

b.Disc currently being played:

The type of disc currently inserted is displayed.

c.Elapsed playing time:

When disc information screen 2 is displayed, it is not possible to enter an elapsed playing time.

Unit information screen 2

CD

- 1 Press **DISPLAY** twice in Play or Stop mode to display “On-Screen Display.”
- 2 Press **SET** to enter. Cursor moves to the right. Change the item by pressing **▲▼**, and press **SET**.

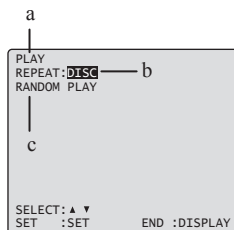

a.OPERATING MODE:

The current operation is displayed.

b.REPEAT MODE:

REPEAT MODE can be selected.

Example:

CURRENT PLAYBACK POSITION

	track	track	track
REPEAT:TRACK		→	
REPEAT:DISC	→		
REPEAT:OFF			→

c.Play mode:

When Play mode is set (see pages 50-51), the mode name is displayed.

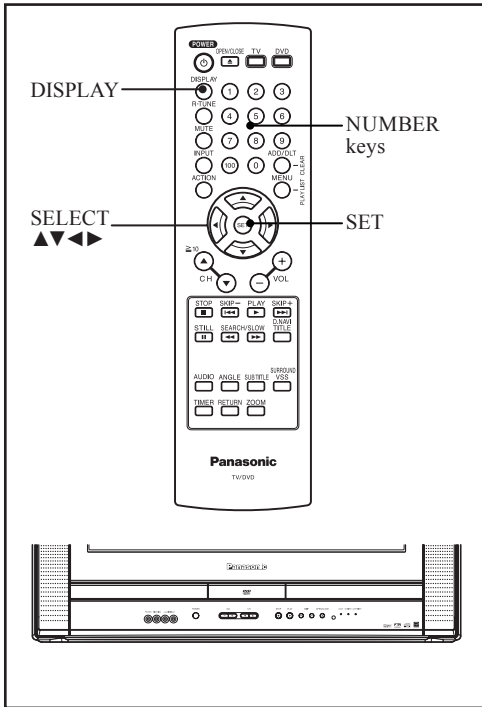

Disc information screen 3

DVD-RAM

- 1 Press **DISPLAY** in Play or Stop mode to display "On-Screen Display."
- 2 Press **◀▶** to select an item.

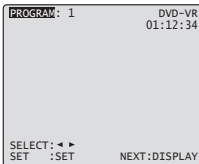

- 3 Press **SET** to enter selected item. Cursor moves to the right. Change the item by pressing **▲▼** or the **NUMBER** keys, and press **SET**.

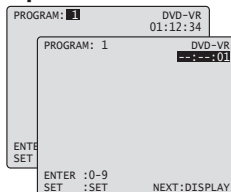

Example:
Direct Navigation (PROGRAM)

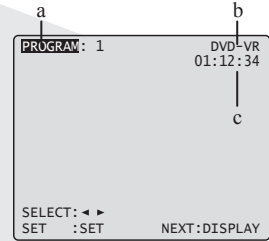

Example:
PLAY LIST

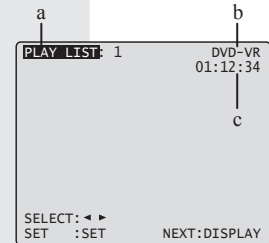

a.Direct Navigation (PROGRAM) or PLAY LIST No.:

Go directly to a preset title number.

b.Disc currently being played:

The type of disc currently inserted is displayed.

c.Elapsed playing time:

Go to a different scene by entering an elapsed playing time, then **SET**.

- This function does not work with some discs.
- If **SET** is pressed while making entries, unit returns to the condition before entries were made.

Example:

12 : 34 : 56 1 → 2 → 3 → 4 → 5 → 6
00 : 20 : 00 2 → 0 → 0 → 0 → SET

- When  appears on the screen while a button is being pressed, it means that the corresponding operation is prohibited by the unit or the disc.

Unit information screen 3

DVD-RAM

- 1 Press **DISPLAY** twice in Play or Stop mode to display “On-Screen Display.”
- 2 Press **SET** to enter. Cursor moves to the right. Change the item by pressing **▲▼** and press **SET**.

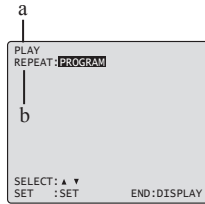

a.OPERATING MODE:

The current operation is displayed.

b.REPEAT MODE:

REPEAT MODE can be selected.

Example: Direct Navigation
(PROGRAM)

CURRENT PLAYBACK POSITION

	PROGRAM	PROGRAM	PROGRAM
REPEAT:PROGRAM		→	
REPEAT:DISC	→	→	→
REPEAT:OFF			→

Example: PLAY LIST

CURRENT PLAYBACK POSITION

	PLAY LIST	PLAY LIST	PLAY LIST
REPEAT:PLAY LIST		→	
REPEAT:ALL PLAY LIST	→	→	→
REPEAT:OFF			→

Special Disc Operation

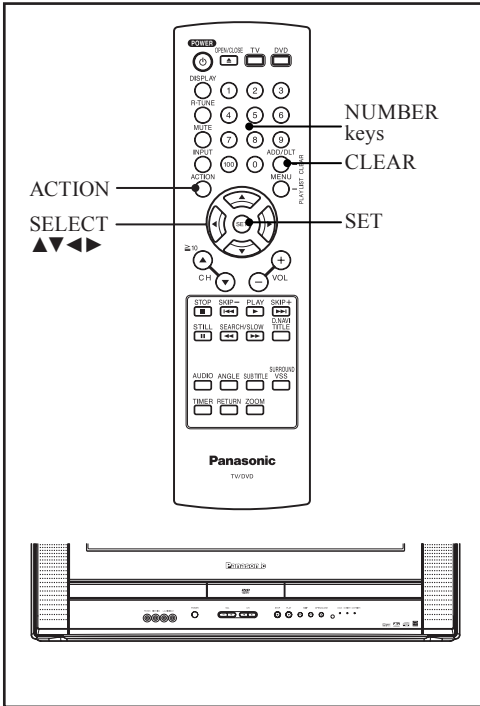

- 6 Press **▲▼** to select “PROGRAM PLAY.”
- 7 Press **SET** to display screen.

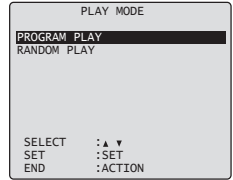

- 8 Press **▲▼◀▶** to select a track number.
(Track numbers on disc are displayed.)
- 9 Press **SET** to set.
 - Repeat steps 8-9 to select another track.
 - The selected track is added on the right side.

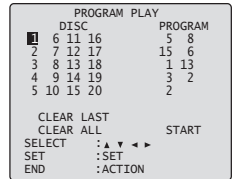

Program Play

CD

You can program specific tracks and order of play.

- 1 Press **ACTION** in Stop mode to display **MAIN MENU**.
- 2 Press **▲▼◀▶** to select “**DVD.**”
- 3 Press **SET** to display **DVD MAIN MENU**.

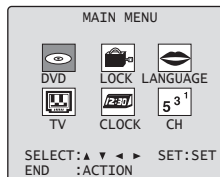

- 4 Press **▲▼** to select “**PLAY MODE.**”
- 5 Press **SET** to display **PLAY MODE** screen.

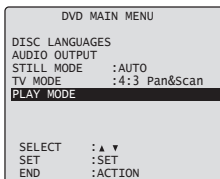

- 10 Press **▲▼◀▶** to select “**START.**”
- 11 Press **SET** to start play of programs in the sequence selected.

To cancel, press **STOP** during play, then press **CLEAR**.

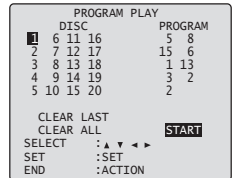

Notes

- Up to 15 tracks can be programmed.
- “◀” or “▶” (depending on disc) indicates additional PROGRAM PLAY screen. Press **▲▼◀▶** for next or previous screen.
- To clear the last program one by one, Press **▲▼◀▶** to move to “CLEAR LAST” and press **SET**. (Pressing **CLEAR** also clears last program.)
- To clear all programs, Press **▲▼◀▶** to move to “CLEAR ALL” and press **SET**. (Programs are also cleared when the power is turned off or the disc is removed.)

- When  appears on the screen while a button is being pressed, it means that the corresponding operation is prohibited by the unit or the disc.

Program Repeat Play

CD

1 Do steps 1-11 on page 50.

2 Press DISPLAY to display Disc Information screen.

(Disc Information Screen)

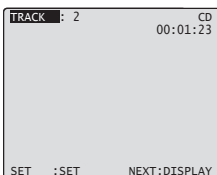

3 Press DISPLAY again to display Unit Information screen.

4 Press SET to enter Select mode. Cursor moves to "OFF."

(Unit Information Screen)

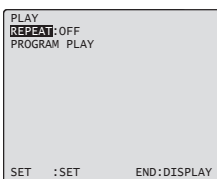

5 Press \blacktriangle \blacktriangledown to select "DISC."

(Unit Information Screen)

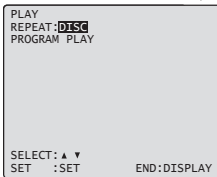

6 Press SET to set mode. Cursor moves to "REPEAT." To cancel, select "REPEAT OFF" in step 5, then press SET.

Random Play

CD

Tracks are played in random order.

1 Press ACTION in Stop mode to display MAIN MENU.

2 Press \blacktriangle \blacktriangledown \blacktriangleleft \blacktriangleright to select "DVD."

3 Press SET to display DVD MAIN MENU.

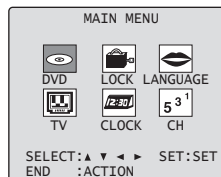

4 Press \blacktriangle \blacktriangledown to select "PLAY MODE."

5 Press SET to display PLAY MODE screen.

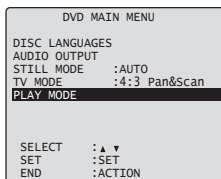

6 Press \blacktriangle \blacktriangledown to select "RANDOM PLAY."

7 Press SET to begin random play.

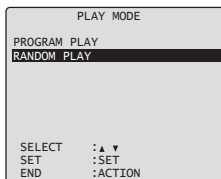

To cancel, press STOP during play, then press CLEAR.

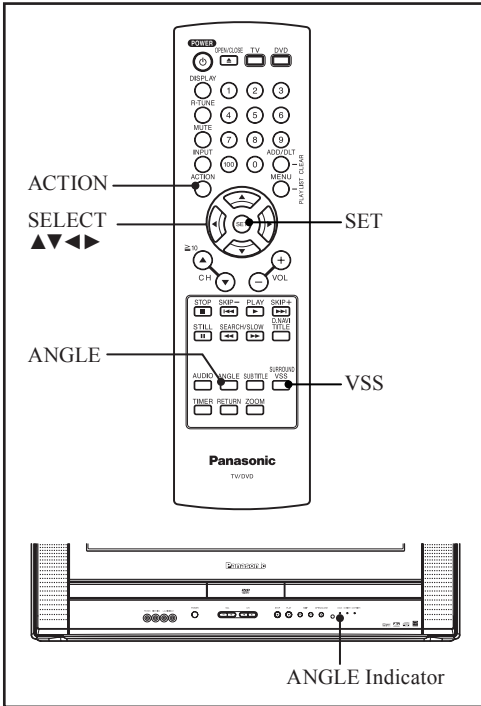

DVD Volume Adjust

DVD-V

Some DVDs are recorded at lower than average volume levels. For these DVDs, this unit can be set so that the average volume is increased automatically.

- 1 Press **ACTION** to display **MAIN MENU**.
- 2 Press **▲▼◀▶** to select "TV."
- 3 Press **SET** to display **SET UP TV** screen.

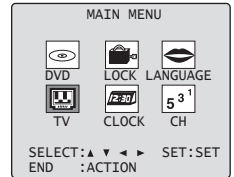

- 4 Press **▲▼** to select "DVD VOL ADJUST."
- 5 Press **SET** to set the level (0, +1, or +2).

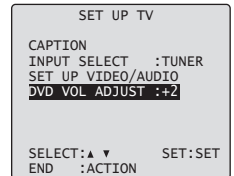

- 6 Press **ACTION** twice to return to the normal screen.

Note

- DVD Volume Adjust works only when sound is in Dolby Digital.

- When  appears on the screen while a button is being pressed, it means that the corresponding operation is prohibited by the unit or the disc.

V.S.S. (Virtual Surround Sound)

DVD-V CD DVD-RAM

Enjoy a surround-like effect if you are using two front speakers only. The effect is broadened and sound seems to come from virtual speakers on either side if the disc has surround signals recorded on it.

Press VSS in Disc mode.

- The Surround sound effects can be changed by pressing VSS repeatedly as shown in the figure below.

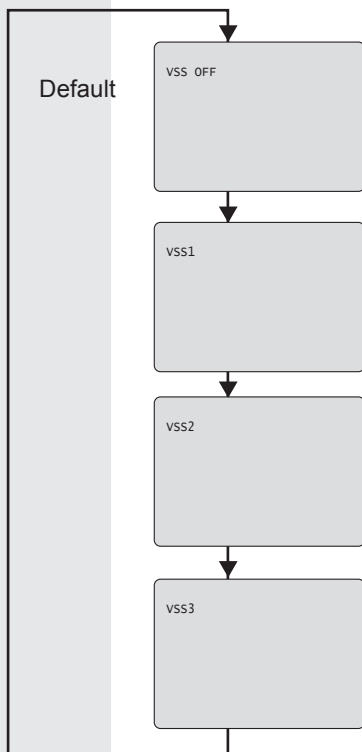

Notes

- Turn off the surround effects on the other equipment.
- V.S.S. will not work, or will have less effect, with some discs.
- Turn V.S.S. off if it causes distortion.

Multiple Angle Viewing

DVD-V

DVDs may contain scenes shot from multiple camera angles allowing the same scene to be viewed from different angles. You can view these angles, if available, using the ANGLE button.

1 Press ANGLE in Play mode to display the angle selection on-screen.

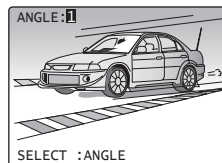

2 Press ANGLE repeatedly to select the desired angle.

- Display disappears after 5 seconds.

Number of angle being played back.

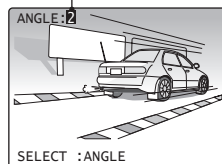

Notes

- This function not available with DVD-RAM.
- ANGLE Indicator lights up on the unit when a scene recorded from different angles is detected.
- The angle number can be set beforehand so that the angle is switched whenever ANGLE Indicator lights up.

Settings for DVD Operation

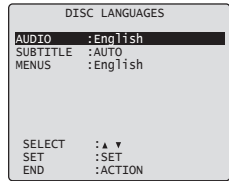
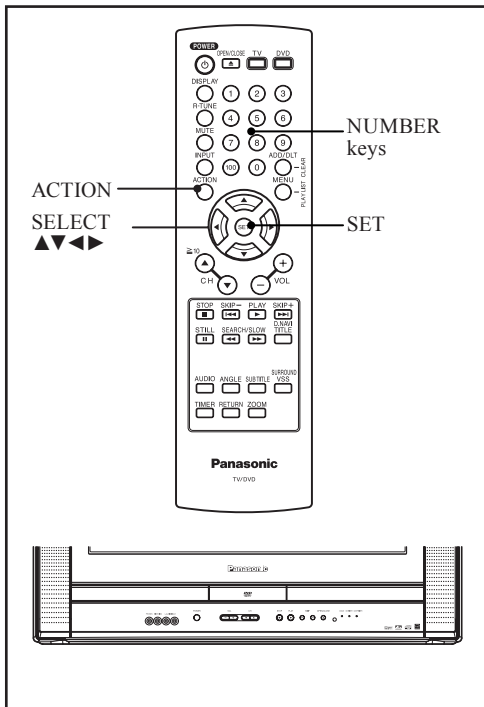

- Press **▲▼** to select an item.
- Press **SET** repeatedly for desired language.

■ AUDIO

To select the audio soundtrack language. (Factory preset: English)

English/Spanish/French/Japanese

Original: Original disc language

Other ** :**Other language selection^{*1}

■ SUBTITLE

To select the subtitle language. (Factory preset: AUTO)

AUTO: Same language selected for "AUDIO"

- If language set for "AUDIO" is used in playback, subtitles will not appear.
- If another language is used during playback, the subtitles will appear in the language selected at "AUDIO" setup.

English/Spanish/French/Japanese

Other ** :**Other language selection^{*1}

■ MENUS

To select the language used in title menus or DVD menus. (Factory preset: English)

English/Spanish/French/Japanese

Other ** :**Other language selection^{*1}

^{*1} If the selected language is not offered, the original disc language is selected.

To enter OTHER ** code number, Press NUMBER keys** (Please refer to next page).

To make corrections, press **◀** repeatedly to delete language code number, and correct.

- Once initial settings are done, they remain in memory (even after the power is off) until changed. This means the unit will always operate under the same conditions (especially DVDs) each time.

- Press **ACTION** twice to exit this mode.

Disc Languages

DVD-V

To select and set the language of the audio soundtrack, subtitles, or title/DVD menus for all discs to be played.

- Press **ACTION** in Stop mode to display **MAIN MENU**.
- Press **▲▼◀▶** to select "DVD."
- Press **SET** to display **DVD MAIN MENU**.
- Press **▲▼** to select "DISC LANGUAGES."
- Press **SET** to display **DISC LANGUAGES** screen.

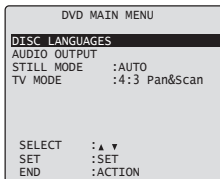
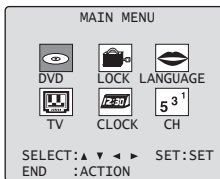

- When  appears on the screen while a button is being pressed, it means that the corresponding operation is prohibited by the unit or the disc.

Language Code List

Language	Code
Abkhazian	6566
Afar	6565
Afrikaans	6570
Albanian	8381
Ameharic	6577
Arabic	6582
Armenian	7289
Assamese	6583
Aymara	6588
Azerbaijani	6590
Bashkir	6665
Basque	6985
Bengali; Bangla	6678
Bhutani	6890
Bihari	6672
Breton	6682
Bulgarian	6671
Burmese	7789
Byelorussian	6669
Cambodian	7577
Catalan	6765
Chinese	9072
Corsican	6779
Croatian	7282
Czech	6783
Danish	6865
Dutch	7876
English	6978
Esperanto	6979
Estonian	6984
Faroese	7079
Fiji	7074
Finnish	7073
French	7082
Frisian	7089
Galician	7176
Georgian	7565
German	6869
Greek	6976
Greenlandic	7576
Guarani	7178
Gujarati	7185

Language	Code
Hausa	7265
Hebrew	7387
Hindi	7273
Hungarian	7285
Icelandic	7383
Indonesian	7378
Interlingua	7365
Irish	7165
Italian	7384
Japanese	7465
Javanese	7487
Kannada	7578
Kashmiri	7583
Kazakh	7575
Kirghiz	7589
Korean	7579
Kurdish	7585
Laothian	7679
Latin	7665
Latvian, Lettish	7686
Lingala	7678
Lithuanian	7684
Macedonian	7775
Malagasy	7771
Malay	7783
Malayalam	7776
Maltese	7784
Maori	7773
Marathi	7782
Moldavian	7779
Mongolian	7778
Nauru	7865
Nepali	7869
Norwegian	7879
Oriya	7982
Panjabi	8065
Pashto, Pushto	8083
Persian	7065
Polish	8076
Portuguese	8084
Quechua	8185
Rhaeto-Romance	8277

Language	Code
Romanian	8279
Russian	8285
Samoaan	8377
Sanskrit	8365
Scots Gaelic	7168
Serbian	8382
Serbo-Croatian	8372
Shona	8378
Sindhi	8368
Singhalese	8373
Slovak	8375
Slovenian	8376
Somali	8379
Spanish	6983
Sundanese	8385
Swahili	8387
Swedish	8386
Tagalog	8476
Tajik	8471
Tamil	8465
Tatar	8484
Telugu	8469
Thai	8472
Tibetan	6679
Tigrinya	8473
Tonga	8479
Turkish	8482
Turkmen	8475
Twi	8487
Ukrainian	8575
Urdu	8582
Uzbek	8590
Vietnamese	8673
Volapük	8679
Welsh	6789
Wolof	8779
Xhosa	8872
Yiddish	7473
Yoruba	8979
Zulu	9085

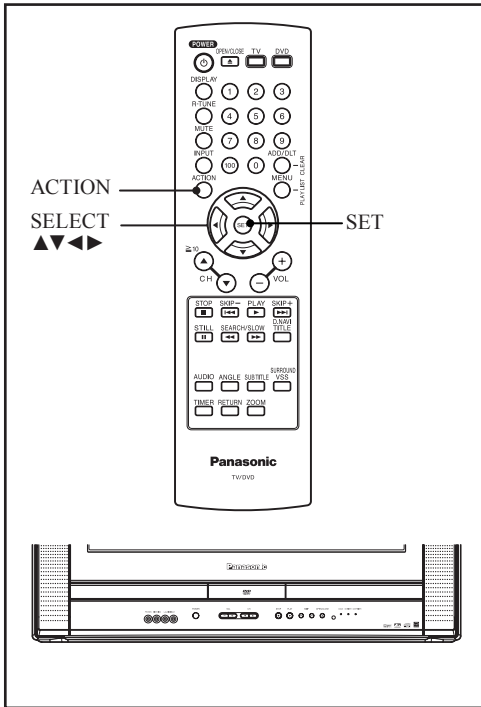

Selecting AUDIO OUTPUT

DVD-V

Select the digital output to be output from the optical digital audio output connector of the unit.

- 1 Press **ACTION** in Stop mode to display **MAIN MENU**.
- 2 Press **▲▼◀▶** to select “**DVD**.”
- 3 Press **SET** to display **DVD MAIN MENU**.

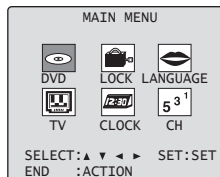

- 4 Press **▲▼** to select “**AUDIO OUTPUT**.”
- 5 Press **SET** to display **AUDIO OUTPUT** screen.

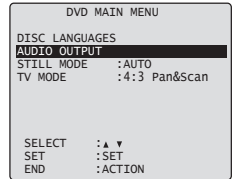

- 6 Press **▲▼** to select an item.
- 7 Press **SET** repeatedly for desired output.

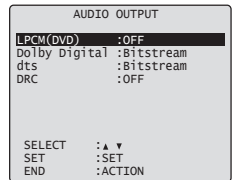

■ LPCM (DVD)

OFF:

Linear PCM of less than 48 kHz/16 bit is output. When playing DVDs recorded in linear PCM of over 48 kHz/20 bit, no digital audio is output. (Factory preset)

PCM:

When playing DVDs recorded in linear PCM of 48 kHz/20 bit/24 bit or more, digital audio converted to 44.1 kHz/16 bit or 48 kHz/16 bit is output. (Digital output of PCM audio is restricted to 48 kHz/16 bit or below for copyright protection.)

■ Dolby Digital

Bitstream:

Dolby Digital bitstream (1ch-5.1ch) is output. (Factory preset)

PCM:

When you have connected an amplifier that doesn't have a built-in Dolby Digital decoder.

■ dts selections

Bitstream:

dts bitstream is output. (Factory preset)

PCM:

When you have connected an amplifier that doesn't have a built-in dts decoder.

- When  appears on the screen while a button is being pressed, it means that the corresponding operation is prohibited by the unit or the disc.

■ DRC (Dynamic Range Compression)

OFF:

Normal audio range is selected. (Factory preset)

ON:

For dynamic sound even at low volume. This is useful for late-night listening. [Dolby Digital DVDs only].

Type of amplifier to be connected	Recommended setting		
	LPCM (DVD)	Dolby Digital	dts
No amplifier is connected			
AV amplifier without Dolby Digital/dts decoder	PCM	PCM*1	PCM*1
AV amplifier including Dolby Digital decoder	PCM	Bitstream*3	PCM
AV amplifier including Dolby Digital/dts decoder	PCM	Bitstream*3	Bitstream*2

- *1 When connecting an amplifier (with an optical digital input connector) which does not contain the Dolby Digital or dts decoder, be sure to select "PCM." If "Bitstream" is selected, starting DVD play may cause such a high level of noise as to be harmful to your ears and damage the speakers.
- *2 When a dts decoder is connected, please select "Bitstream" in "dts." If "PCM" is selected, there will be stereo sound.
- *3 When a Dolby Digital decoder is connected, please select "Bitstream" in "Dolby Digital." If "PCM" is selected, there will be stereo sound.

Note







- Make settings according to amplifier connected to optical audio output as shown in above table.

- 8 Press ACTION to redisplay DVD MAIN MENU and go to step 4 to set up another item. Or, press ACTION three times to exit.

Selecting STILL MODE

DVD-V

Set to reduce jitter in a displayed still picture or a motion picture.

- 1 Press ACTION in Stop mode to display MAIN MENU.
- 2 Press     to select "DVD."
- 3 Press SET to display DVD MAIN MENU.
- 4 Press   to select "STILL MODE."
- 5 Press SET repeatedly for mode.

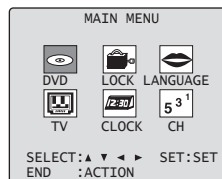

- 4 Press   to select "STILL MODE."
- 5 Press SET repeatedly for mode.

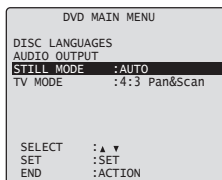

■ AUTO:

"FIELD" (Field still) or "FRAME" (Frame still) is automatically selected during the still mode. (Factory preset)

■ Field:

"FIELD" (Field still) is always selected. This setting will reduce jitter when compared with "AUTO" on some discs.

■ Frame:

"FRAME" (Frame still) is always selected. Some texts and fine patterns will be seen clearly when compared with "AUTO" on some discs.

- 6 Press ACTION twice to exit this mode.

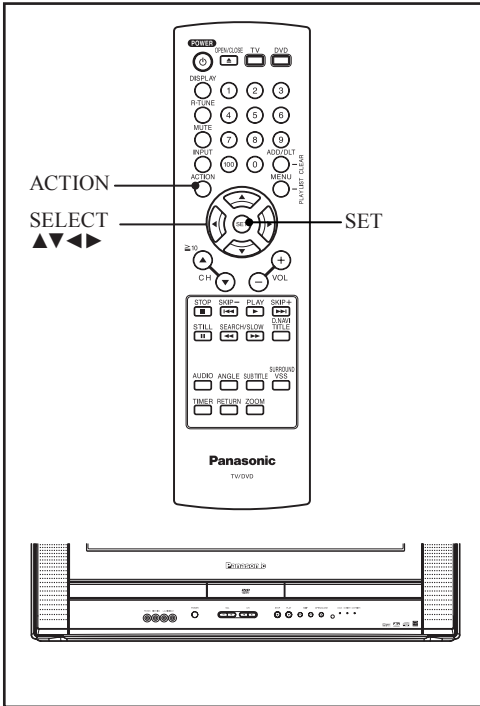

Selecting TV MODE

DVD-V

Set the screen display style for widescreen video material playback.

- 1 Press **ACTION** in Stop mode to display **MAIN MENU**.
- 2 Press **▲▼◀▶** to select "DVD."
- 3 Press **SET** to display **DVD MAIN MENU**.

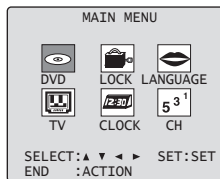

- 4 Press **▲▼** to select "TV MODE."
- 5 Press **SET** repeatedly for mode.

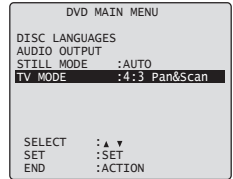

4:3 Pan & Scan:

Widescreen video data is played in Pan & Scan style (left and right of screen is trimmed.)

- Video data not formatted in Pan & Scan will play in letterbox style.

(Factory preset)



4:3 Letterbox:

Widescreen video data is played in Letterbox style (top and bottom of screen display a black margin).



- 6 Press **ACTION** twice to exit this mode.

Warning and Instruction Displays

These displays will alert you to a missed operation or provide further instructions.

OSD	CAUTION	Page
PLEASE SET CLOCK BY PRESSING ACTION KEY	If you attempt to set or review a Timer Recording or set the On-Timer and the Clock is not set...	20
PLEASE CHECK THE DISC, AND FOR STAINS OR SCRATCHES ON DISC	If you press PLAY, or the unit reads data from a stained or scratched disc in DVD mode. Also, if the type of disc is other than DVD or CD...	10
THIS DISC MAY NOT BE PLAYED IN YOUR REGION	Playback of a disc with different region number was attempted. Only discs marked region "1," "ALL," or those that include "1" are playable on this unit.	10
THIS TYPE OF DISC CANNOT BE PLAYED. PLEASE INSERT A DIFFERENT DISC	An unusable disc is inserted in the unit, or the disc is not inserted with label side up.	9

Before Requesting Service

Check the following points once again if you are having trouble with your unit.

	PROBLEM	CORRECTION	Page
Power	No power...	Completely insert Power Plug into an AC outlet.	13
		Set POWER button to ON.	11-12
	Power turns itself off...	Auto power-off (shut off) occurs after about 5 min. in DVD mode with no operation, or if there is no broadcast signal in TV or Playback mode. Turn the power back on.	37-38

Monitor	No picture or sound...	Make sure your antenna system (TV or CABLE) is correctly set.	14
		Completely insert Power Plug into an AC outlet.	13
		Set POWER button to ON.	11-12
	Poor picture with normal sound...	Adjust BRIGHTNESS, SHARPNESS, and PICTURE controls in the SET UP Video Adjustment.	28-29
	Poor sound with normal picture...	Adjust VOLUME control.	22
	Poor TV reception...	Adjust SHARPNESS and PICTURE controls in the SET UP Video Adjustment.	28-29
	No color or poor color...	Adjust TINT and COLOR controls in the SET UP Video Adjustment.	28-29
	Ghost (multiple) images...	Install a directional antenna.	14
TV programs cannot be watched...	Make sure the selected channel is in unit's memory.	19	

Remote Control	Unit cannot be controlled...	Aim Remote directly at the remote sensor on the unit. Avoid any object blocking signal path.	12
		Inspect the remote batteries.	8
		Exposing unit remote sensor to direct fluorescent or outdoor light may cause signal interference.	12
	ACTION, PLAY, SELECT, SET POWER, etc. buttons cannot be selected...	Press TV for TV mode.	12
		Press DVD for DVD mode.	12
		Check remote batteries.	8

PROBLEM	CORRECTION	Page
Play fails to start even when PLAY is pressed...	This unit cannot play discs other than DVDs and CDs.	9
	The disc may be dirty and require cleaning.	10
Picture is distorted during rapid advance or rapid reverse...	The picture will be somewhat distorted at times: this is normal.	
No Forward/Reverse search play...	Some discs may have sections which prohibit Forward/Reverse search.	39
Audio soundtrack and/or subtitle language is not the one selected at the initial settings...	The audio soundtrack and/or subtitle language selected at DVD initial settings must exist on the disc.	41-42
No subtitles...	Subtitles appear only when available on disc.	42
	Select "ON" at the "Subtitle language" section to display subtitles.	42
Alternative audio soundtrack (or subtitle) language cannot be selected...	Alternative language cannot be selected with discs which do not contain more than one language.	41
	For some discs, alternative language cannot be selected with the AUDIO or SUB TITLE button. Try selecting it from the DVD menu if available.	41
Angle cannot be changed...	This function is dependent on software availability. Even if disc has multiple angles, they may be recorded for specific scenes only (ANGLE Indicator on unit lights up).	53

If you cannot resolve the problem, please call the Customer Satisfaction Center for product assistance at 1-800-211-PANA(7262).

To locate an authorized servicenter call toll free 1-800-211-PANA(7262) or, contact us via the web at: <http://www.panasonic.com/contactinfo>

Guía rápida de uso en español - Conexión -

Notas sobre las conexiones

- Desconecte la alimentación de todos los componentes antes de realizar cualquier conexión.
- Si los cables necesarios para conectar un componente al sistema no están incluidos con el componente o disponibles opcionalmente, quizás deba adoptar un cable para que se adecue al componente involucrado.
- Consulte cuidadosamente el manual de instrucciones de cada componente del sistema antes de conectarlo.

Conexión del terminal de entrada RF

⚠ PRECAUCIÓN

Apretar demasiado los cables coaxiales RF “tipo tuerca” podría dañar los conectores. Asegúrelos solamente con los dedos.

■ Conexión de la antena

Conecte el cable de la antena al terminal VHF/UHF de la unidad.

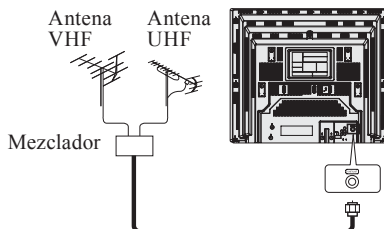

■ Conexión del cable

Conecte el cable suministrado por la compañía de cable local al terminal VHF/UHF de la unidad.

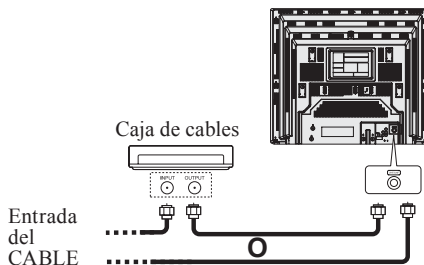

Nota para el instalador del sistema de CABLE:

Este recordatorio tiene la finalidad de llamar la atención a los instaladores del sistema de CABLE (televisión por cable) sobre el artículo 820-40 de NEC que brinda pautas para una conexión a tierra apropiada y, en particular, especifica que la tierra del cable se deberá conectar al sistema de tierra del edificio, tan cerca del punto de ingreso del cable como sea práctico.

Conexión del terminal de entrada AV

Conecta videograbadores y otros equipos periféricos

■ Se usa el terminal Video

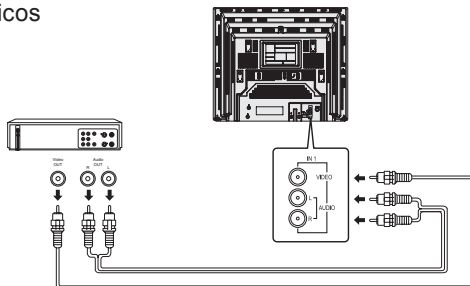

Configuración inicial (listo para reproducir)

Por favor realice todas las conexiones del cable o antena antes de conectar la alimentación.

Enchufe el cable de alimentación de la unidad en un tomacorriente de CA.

Presione POWER en el control remoto o unidad. Comienza el ajuste automático de reloj y canal.

- Si usa una caja de cables, debe encenderla y ajustarla al canal de servicio de difusión pública (PBS) en su zona horaria. Si usa un receptor DSS, éste debe estar apagado.

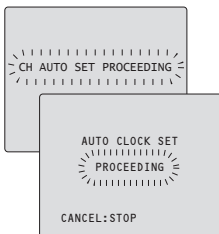

- Los botones de funciones no funcionarán durante la configuración inicial.
- Dependiendo de las condiciones, el ajuste automático de reloj podría llevar más de 30 minutos. En tal caso, presione STOP para detener la configuración y realizar los ajustes manualmente.

Caso 1

Los ajustes se realizan automáticamente. Cuando se termina la configuración, aparecerá la siguiente pantalla.

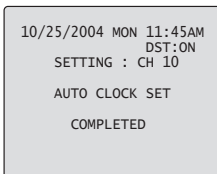

Caso 2

Si la configuración no está completa, aparecerá la siguiente pantalla. Verifique la conexión de la antena/cable al terminal de entrada RF, luego pruebe ajustar manualmente el reloj de la siguiente manera.

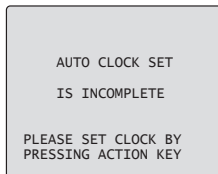

a. Presione ACTION del control remoto para exhibir la pantalla de menú SET CLOCK.

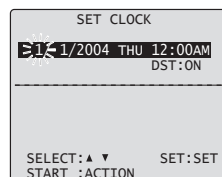

b. Presione ▲▼ para seleccionar el mes y presione SET para ajustarlo. De la misma manera, seleccione y ajuste la fecha, año, hora, y DST (hora de verano).

- Presione ◀ repetidamente para mover el cursor. Presione ▲▼ para realizar la corrección.

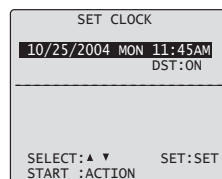

c. Presione ACTION dos veces para arrancar el reloj y salir.

Selección del modo de entrada

■ Método 1:

Presione CH ▲▼. La exhibición cambiará de la siguiente manera.

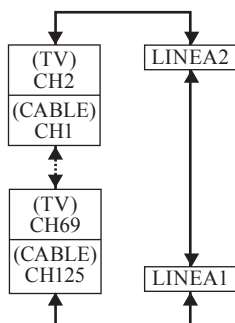

■ Método 2:

Presione INPUT. La exhibición cambiará de la siguiente manera.



■ Método 3:

1 Presione ACTION para acceder al MENU PRINCIPAL.

2 Presione ▲▼◀▶ para seleccionar "TV", luego presione SET para acceder a la pantalla PREPARAR.

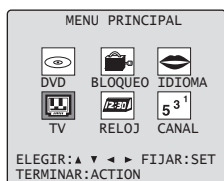

3 Presione ▲▼ para seleccionar "ENTRADA", y luego presione SET para seleccionar "SINTONIZADOR", "LINEA1" o "LINEA2".

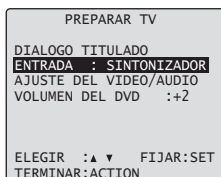

4 Presione ACTION dos veces para salir de este modo.

LINEA1:

Se exhibe la señal de la fuente conectada al terminal de entrada AV1.

LINEA2:

Se exhibe la señal de la fuente conectada al terminal de entrada AV2.

SINTONIZADOR:

Se exhibe la señal de la fuente conectada al terminal VHF/UHF.

Uso del botón CH/VOL

Seleccione el canal deseado:

Presione CH ▲▼ o las teclas NUMBER.

Ajuste el nivel de volumen deseado:

Presione VOL + o VOL -.

Uso de la tecla Number y 100

Cuando esté seleccionando canales de CABLE del 100 al 125 con las teclas NUMBER, primero presione la tecla 100, y luego ingrese los dos dígitos restantes.

Ejemplo 1:

Para seleccionar el canal 125, primero presione la tecla 100, luego 2, luego 5.

Ejemplo 2:

Para seleccionar el canal 12, primero presione el 1, luego el 2.

Ejemplo 3:

Para seleccionar el canal 2, primero presione el 2.

Sintonización rápida

Presione R-TUNE para exhibir el último canal que estaba mirando.

Apagado del audio

Presione MUTE para apagar instantáneamente el sonido. Presione de nuevo para restaurar el sonido a su nivel anterior.

Guía rápida de uso en español - Funcionamiento del disco-

Reproducir disco

- 1 Presione **POWER** en el control remoto o en la unidad.
- 2 Presione **DVD** para ajustar el modo remoto a DVD.
- 3 Presione **OPEN/CLOSE**.
 - Si ya está insertado un disco, vaya al paso 5. (Dependiendo del disco, la reproducción puede comenzar automáticamente.)
- 4 Coloque un disco en la bandeja de discos.
 - Sujete el disco por sus bordes solamente con el lado impreso hacia arriba y use las guías para colocarlo en la bandeja. Use un disco de ① 3" (8 cm) o ② 5" (12 cm).

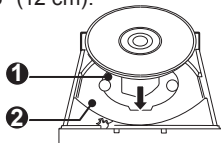

- 5 Presione **PLAY** para comenzar la reproducción. La bandeja de disco se cierra automáticamente.
 - También puede cerrar la bandeja presionando **OPEN/CLOSE**.
 - El tiempo de lectura de los datos difiere con cada disco.

<Ejemplo>

Si se usa un DVD interactivo y aparece un menú principal del DVD, vaya al paso 6.



- 6 Presione **▲▼◀▶** para seleccionar el título y presione **SET** para comenzar la reproducción. **O**, presione las teclas **NUMBER** para comenzar a reproducir automáticamente.
 - El número de títulos disponibles varía con cada disco.

■ Detención de un disco

Presione **STOP** para detener la reproducción.

■ Para volver al menú principal del DVD (se detiene la reproducción)

Presione **TITLE**, **MENU** o **RETURN**.

- 7 Presione **OPEN/CLOSE** para expulsar el disco.

Uso de las teclas NUMBER

DVD-V CD DVD-RAM

Cuando se usan teclas **NUMBER** en el modo de disco, el funcionamiento es diferente que en el modo de televisión.

Ejemplo 1:

Para seleccionar el canal 12, primero presione la tecla ≥ 10 , luego 1, luego 2.

Ejemplo 2:

Para seleccionar el canal 2, primero presione el 2.

Búsqueda de escena rápida hacia adelante/atrás

DVD-V CD DVD-RAM

- 1 Presione **SEARCH ►► /SLOW+** o **SEARCH ◀◀ /SLOW-** durante la reproducción.
 - La velocidad de búsqueda, lenta al principio, aumenta con cada presión adicional del botón hasta 5 niveles.
- 2 Presione **PLAY** para cancelar.

Saltar hacia delante/atrás un capítulo o pista

DVD-V CD DVD-RAM

- 1 Presione **SKIP+ ►►►** o **SKIP- ◀◀◀** durante la reproducción.

DVD y CD

• Al presionar **SKIP- ◀◀◀** una vez hasta la mitad durante un capítulo o pista se vuelve al comienzo de ese capítulo o pista. Cada presión adicional salta hacia atrás un capítulo o pista.

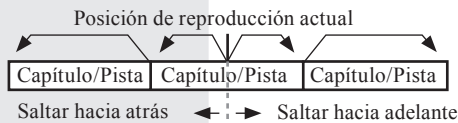

DVD-RAM

• Al presionar **SKIP- ◀◀◀** una vez a la mitad a través de un programa/lista de reproducción se vuelve al comienzo de la programa/lista de reproducción. Cada vez adicional que se presiona se vuelve un programa/lista de reproducción para atrás.

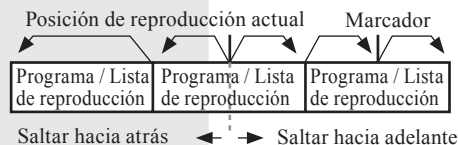

- 2 Cada vez que se presiona un capítulo (DVD), pista (CD) o programa/lista de reproducción/marcador (DVD-RAM).

Función de apagado automático

DVD-V CD DVD-RAM

Desconecta la alimentación después que la unidad ha estado en el modo de detención exhibiendo el fondo de pantalla durante unos cinco minutos.

Imagen fija (pausa)

DVD-V CD DVD-RAM

1 Presione STILL durante la reproducción.

- DVD:
La unidad ingresará en el modo de imagen fija.
- CD:
La unidad ingresará al modo de pausa.

2 Presione PLAY para cancelar.

Imagen cuadro a cuadro

DVD-V DVD-RAM

1 Presione STILL en el modo de imagen fija.

- Cada presión avanza la imagen un cuadro.
- Mantenga presionado para obtener un avance continuo de los cuadros.

2 Presione PLAY para cancelar.

Imagen en cámara lenta

DVD-V DVD-RAM

1 Presione SEARCH ►► /SLOW+ o SEARCH ◀◀ /SLOW- en el modo de imagen fija.

- Velocidad de cámara lenta, lenta al principio, aumenta con cada presión adicional del botón hasta 5 niveles.

2 Presione PLAY para cancelar.

Función de continuación

DVD-V CD DVD-RAM

La unidad memoriza el punto donde se presiona STOP (exhibición de PARADA ► en la pantalla).

Presione PLAY para retomar la reproducción a partir de ese punto.

Al presionar STOP de nuevo en el modo DVD o abrir la bandeja se cancela la función de continuación, sin embargo, no se cancela esta función cuando se desconecta y conecta la alimentación.

Idioma de la banda sonora

DVD-V

Puede cambiar el idioma de la banda sonora, seleccionado en los ajustes de funcionamiento del DVD, a un idioma diferente, si está disponible.

1 Presione AUDIO en el modo de reproducción para exhibir la selección de audio en la pantalla.

- La exhibición desaparece después de cinco segundos.

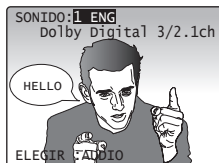

2 Presione AUDIO, ▲▼, o las teclas NUMBER para seleccionar el idioma deseado.



Idioma de los subtítulos

DVD-V DVD-RAM

Puede seleccionar un idioma de subtítulos diferente (si se ofrece) al ajustado en los ajustes de funcionamiento del DVD.

1 Presione SUBTITLE en el modo de reproducción para exhibir la selección de subtítulos en la pantalla.

- La exhibición desaparece después de cinco segundos.



2 Presione SUBTITLE, ▲▼, o teclas NUMBER para seleccionar el idioma deseado.



Lista de reproducción

DVD-RAM

Si entre las características del DVD-RAM se incluye una lista de reproducción, a fin de brindar un fácil acceso se exhibe su lista preseleccionada de escenas favoritas. (El funcionamiento puede variar de acuerdo a como editó el DVD-RAM.)

- 1 Presione **PLAYLIST** en el modo de reproducción / detención para exhibir el menú de lista de reproducción.

Play List		Pagina1/5	
No.	Fecha	Longitud	Título
1	2002/12/24 5:15:41AM	00:01:00	Reproducción de película
2	2002/12/25 4:31:49AM	00:03:12	Reproducción de imagen fija
3	2002/12/25 8:24:25AM	00:15:01	Reproducción híbrida
4	2002/12/25 12:45:00AM	00:03:00	Reproducción parcial

ELEGIR: ▲ ▼ ◀ ▶
FIJAR :SET TERMINAR:MENU

- 2 Presione **▲▼** para seleccionar una página y presione **◀▶** o las teclas **NUMBER** para seleccionar un título (número de lista de reproducción).

Play List		Pagina1/5	
No.	Fecha	Longitud	Título
1	2002/12/24 5:15:41AM	00:01:00	Reproducción de película
2	2002/12/25 4:31:49AM	00:03:12	Reproducción de imagen fija
3	2002/12/25 8:24:25AM	00:15:01	Reproducción híbrida
4	2002/12/25 12:45:00AM	00:03:00	Reproducción parcial

ELEGIR: ▲ ▼ ◀ ▶
FIJAR :SET TERMINAR:MENU

- 3 Presione **SET** o **PLAY**, para comenzar la reproducción.

- No es necesario que presione SET o PLAY cuando esté usando las teclas NUMBER.

Al usar las teclas NUMBER se comienza automáticamente la reproducción.

- El número de títulos disponibles varía con cada disco.

Ejemplo 1:

Para seleccionar el número 12, primero presione la tecla ≥ 10 , luego 1, luego dos.

Ejemplo 2:

Para seleccionar el número 2, primero presione el dos.

- 4 Presione **PLAYLIST** para borrar el menú de lista de reproducción.

Navegador directo

DVD-RAM

Si entre las características del DVD-RAM se incluye un Navegador directo, se exhibe una lista de títulos grabados. Simplemente seleccione un número de título y comience la reproducción. (El funcionamiento puede variar con cada disco usado.)

- 1 Presione **D.NAVI** en el modo de reproducción/detención para exhibir el menú del Navegador directo.

Direct Navigator		Pagina1/5	
No.	Fecha	Longitud	Título
1	2002/12/24 5:15:41AM	01:00:00	Drama
2	2002/12/25 4:31:49AM	00:30:00	Pana NEWS
3	2002/12/25 8:24:25AM	01:30:25	Tigers vs. Giants
4	2002/12/25 12:45:00AM	02:00:50	Dinosaurio

ELEGIR: ▲ ▼ ◀ ▶
FIJAR :SET TERMINAR:TITLE

- 2 Presione **▲▼** para seleccionar una página y presione **◀▶** o las teclas **NUMBER** para seleccionar un título (número de programa).

Direct Navigator		Pagina1/5	
No.	Fecha	Longitud	Título
1	2002/12/24 5:15:41AM	01:00:00	Drama
2	2002/12/25 4:31:49AM	00:30:00	Pana NEWS
3	2002/12/25 8:24:25AM	01:30:25	Tigers vs. Giants
4	2002/12/25 12:45:00AM	02:00:50	Dinosaurio

ELEGIR: ▲ ▼ ◀ ▶
FIJAR :SET TERMINAR:TITLE

- 3 Presione **SET** o **PLAY** para comenzar la reproducción.

- No es necesario presionar SET o PLAY cuando esté usando las teclas NUMBER.

Al usar las teclas NUMBER se comienza automáticamente la reproducción.

- El número de títulos disponibles varía con cada disco.

Ejemplo 1:

Para seleccionar el número 12, primero presione la tecla ≥ 10 , luego 1, luego dos.

Ejemplo 2:

Para seleccionar el número 2, primero presione el dos.

- 4 Presione **D.NAVI** para borrar el menú del Navegador directo.

Limited Warranty

PANASONIC CONSUMER ELECTRONICS COMPANY,
DIVISION OF MATSUSHITA ELECTRIC CORPORATION
OF AMERICA
One Panasonic Way Secaucus, New Jersey 07094

PANASONIC SALES COMPANY, DIVISION OF
MATSUSHITA ELECTRIC OF PUERTO RICO, INC.,
AVE. 65 de Infantería, Km. 9.5 San Gabriel Industrial
Park, Carolina, Puerto Rico 00985

Panasonic/Quasar Video Products Limited Warranty

Limited Warranty Coverage

If your product does not work properly because of a defect in materials or workmanship, Panasonic Consumer Electronics Company or Panasonic Sales Company (collectively referred to as "the warrantor") will, for the length of the period indicated on the chart below, which starts with the date of original purchase ("warranty period"), at its option either (a) repair your product with new or refurbished parts, or (b) replace it with a new or a refurbished product. The decision to repair or replace will be made by the warrantor.

Product	Parts	Labor	Service	Contact Number
Camcorder	One (1) Year (except CCD Image Sensor) CCD Image Sensor - 6 (Six) Months	Ninety (90) Days Ninety (90) Days	Carry-In or Mail-In	1-800-211-PANA(7262)
DVD/VCR Deck, A/V Mixer	One (1) Year	Ninety (90) Days	Carry-In or Mail-In	1-800-211-PANA(7262)
TV/VCR, TV/DVD, TV/DVD/VCR Combination	One (1) Year (except CRT) CRT - Two (2) Years	Ninety (90) Days Ninety (90) Days	Carry-In: 21" CRT and Smaller In-Home or Carry-In: 22" CRT and Larger	1-800-211-PANA(7262)
TV/HDR Combination	One (1) Year (except CRT) CRT - Two (2) Years	Ninety (90) Days Ninety (90) Days	In-Home or Carry-In	1-888-843-9788
Rechargeable Batteries (in exchange for defective item)	Ten (10) Days	Not Applicable	Carry-In or Mail-In	1-800-211-PANA(7262)
Tape (in exchange for defective item)	Five (5) Days	Not Applicable	Carry-In or Mail-In	1-800-211-PANA(7262)
Memory Cards (in exchange for defective item)	Ninety (90) Days	Not Applicable	Carry-In or Mail-In	1-800-211-PANA(7262)

During the "Labor" warranty period there will be no charge for labor. During the "Parts" warranty period, there will be no charge for parts. You must carry-in or mail-in your product or arrange for in-home service, as applicable, during the warranty period.

If non-rechargeable batteries are included, they are not warranted. This warranty only applies to products purchased and serviced in the United States or Puerto Rico. This warranty is extended only to the original purchaser of a new product which was not sold "as is". A purchase receipt or other proof of the original purchase date is required for warranty service.

Carry-In, Mail-in or In-Home Service

For Carry-In, Mail-In or In-Home Service (as applicable) in the United States call toll free contact number listed above or visit Panasonic Web Site: <http://www.panasonic.com>

For assistance in Puerto Rico call Panasonic Sales Company (787)-750-4300 or fax (787)-768-2910.

In-Home service, if applicable, requires clear, complete and easy access to the product by the authorized servicer and does not include removal or re-installation of an installed product. It is possible that certain in-home repairs will not be completed in-home, but will require that the product, or parts of the product, be removed for shop diagnosis and/or repair and then returned.

Limited Warranty Limits And Exclusions

This warranty ONLY COVERS failures due to defects in materials or workmanship, and DOES NOT COVER normal wear and tear or cosmetic damage, nor does it cover markings or retained images on the picture tube resulting from viewing fixed images (including, among other things, letterbox pictures on standard 4:3 screen TV's, or non-expanded standard 4:3 pictures on wide screen TV's, or onscreen data in a stationary and fixed location). The warranty ALSO DOES NOT COVER damages which occurred in shipment, or failures which are caused by products not supplied by the warrantor,

or failures which result from accidents, misuse, abuse, neglect, mishandling, misapplication, alteration, faulty installation, set-up adjustments, misadjustment of consumer controls, improper maintenance, power line surge, lightning damage, modification, or commercial use (such as in a hotel, office, restaurant, or other business), rental use of the product, service by anyone other than a Factory Servicenter or other Authorized Servicer, or damage that is attributable to acts of God.

THERE ARE NO EXPRESS WARRANTIES EXCEPT AS LISTED UNDER "LIMITED WARRANTY COVERAGE". THE WARRANTOR IS NOT LIABLE FOR INCIDENTAL OR CONSEQUENTIAL DAMAGES RESULTING FROM THE USE OF THIS PRODUCT, OR ARISING OUT OF ANY BREACH OF THIS WARRANTY. (As examples, this excludes damages for lost time, cost of having someone remove or re-install an installed unit if applicable, or travel to and from the servicer, loss of media or images, data or other memory or recorded content. The items listed are not exclusive, but are for illustration only.)

ALL EXPRESS AND IMPLIED WARRANTIES, INCLUDING THE WARRANTY OF MERCHANTABILITY, ARE LIMITED TO THE PERIOD OF THE LIMITED WARRANTY.

Some states do not allow the exclusion or limitation of incidental or consequential damages, or limitations on how long an implied warranty lasts, so the exclusions may not apply to you.

This warranty gives you specific legal rights and you may also have other rights which vary from state to state. If a problem with this product develops during or after the warranty period, you may contact your dealer or Servicenter. If the problem is not handled to your satisfaction, then write to the warrantor's Consumer Affairs Department at the addresses listed for the warrantor.

PARTS AND SERVICE (INCLUDING COST OF AN IN-HOME SERVICE CALL, WHERE APPLICABLE) WHICH ARE NOT COVERED BY THIS LIMITED WARRANTY ARE YOUR RESPONSIBILITY.

Customer Services Directory

Obtain Product Information and Operating Assistance; locate your nearest Dealer or Servicenter; purchase Parts and Accessories; or make Customer Service and Literature requests by visiting our Web Site at:

<http://www.panasonic.com/support>

or, contact us via the web at:

<http://www.panasonic.com/contactinfo>

You may also contact us directly at:

1-800-211-PANA (7262),

Monday-Friday 9 am-9 pm; Saturday-Sunday 10 am-7 pm, EST.

For hearing or speech impaired TTY users, TTY : 1-877-833-8855

Accessory Purchases

Purchase Parts, Accessories and Instruction Books online for all Panasonic Products by visiting our Web Site at:

<http://www.pasc.panasonic.com>

or, send your request by E-mail to:

npcparts@panasonic.com

You may also contact us directly at:

1-800-332-5368 (Phone) 1-800-237-9080 (Fax Only) (Monday – Friday 9 am to 8 pm, EST.)

Panasonic Services Company

20421 84th Avenue South,

Kent, WA 98032

(We Accept Visa, MasterCard, Discover Card, American Express, and Personal Checks)

For hearing or speech impaired TTY users, TTY : 1-866-605-1277

Service in Puerto Rico

Matsushita Electric of Puerto Rico, Inc. Panasonic Sales Company

Factory Servicenter:

Ave. 65 de Infantería, Km. 9.5, San Gabriel Industrial Park, Carolina, Puerto Rico 00985

Phone (787)750-4300 Fax (787)768-2910

Glossary

Angle

Some DVD discs feature scenes simultaneously shot from different angles. The ANGLE button can be used to view the scene from different angles. (ANGLE Indicator lights up on the unit when a scene recorded from different angles is detected.)

Bitstream

This is the digital form of multi-channel audio data (e.g., 5.1 channel) before it is decoded into its various channels.

Chapter Number

Titles are subdivided into numbered sections. You can quickly search for a favorite scene using these numbers.

Decoder

A decoder restores the coded audio signals on DVDs to normal. This is called decoding.

Dolby Digital

This is a method of coding digital signals developed by Dolby Laboratories. Apart from stereo (2-channel) audio, these signals can also be multichannel audio. A large amount of audio information can be recorded on one disc using this method.

Dolby Pro Logic

A surround system where a 4-channel audio track is recorded as 2 channels and then is restored to 4 channels for play. The surround channel is monaural and can reproduce up to 7 kHz.

DTS (Digital Theater Systems)

This surround system is used in many movie theaters around the world. There is good separation between the channels, so realistic sound effects are possible.

Dynamic range

Dynamic range is the difference between the lowest level of sound that can be heard above the noise of the equipment and the highest level of sound before distortion occurs.

DVD

A high-density optical disc on which high-quality pictures and sound have been digitally recorded. DVD incorporates new video compression technology (MPEG II) and high-density recording technology which allow entire movies to be recorded with incredible playback quality.

Film and video

DVD-Videos are recorded using either film or video. Usually, film is recorded at 24 frames per second, the rate movies are filmed at, while video is recorded at 30 frames per second.

Frame still and field still

Frames are the still pictures that go together to make a moving picture. There are about 30 frames shown each second. One frame is made up of two fields. A regular television shows these fields one after the other to create frames.

A still is shown when you pause a moving picture. A frame still is made up of two alternating fields, so the picture may appear blurred, but overall quality is high. A field still is not blurred, but it has only half the information of a frame still so picture quality is lower.

Linear PCM (pulse code modulation)

These are uncompressed digital signals, similar to those found on CDs.

Regional Code

This is a copyright protection measure unique to DVD-Video. There are 6 regional codes worldwide. In order to play a disc encoded with a regional code, the DVD player must be equipped with the same code.

Sampling bit number

This is the resolution shown in number of bits to determine how faithfully the sampled analog frequency was expressed at the time the signal is converted from analog to digital.

Sampling Frequency

This is the number of times sampling is performed in (1) second shown in Hz units at the time the signal is converted from analog to digital using the PCM method. The greater the number, the higher the sound quality.

Subtitles

Written dialogue which appears at the bottom of the screen.

Time Number

The elapsed play time from the start of a disc or title. Use to quickly find scenes. (May not work with some discs.)

Title Number

For DVD discs with two or more titles, the title is numbered as title 1, title 2, etc.

Track Number

Numbers assigned to tracks on CDs to allow specific tracks to be quickly located.

V.S.S. Feature

Virtual surround sound playback is possible even with only 2 speakers. For example, using this unit's built-in speakers, the 2 speakers of a connected stereo, etc., you can enjoy a surround sound effect. If the disc was recorded in Dolby Digital 5.1 ch, with just the two front L/R speakers, you will feel as if you are hearing sound from nonexistent speakers on both sides of you. This effect also works with Dolby Digital 2-channel discs.

Specifications

Display		
Picture Tube	27 inch, measured diagonally pure flat Picture Tube	
Tuner		
Broadcast Channels	VHF 2 ~ 13, UHF 14 ~ 69	
CABLE Channels	Midband A through I (14 ~ 22) Superband J through W (23 ~ 36) Hyperband AA ~ EEE (37 ~ 64) Lowband A-5 ~ A-1 (95 ~ 99) Special CABLE channel 5A (01) Ultraband 65 ~ 94, 100 ~ 125	
General		
Power Source	120 V AC, 60 Hz	
Power Consumption	Power On	Approx. 146 W
	Power Off	Approx. 1.5 W
Television System	EIA Standard NTSC color	
Speaker	2 pieces 5 W	
Operating Temperature	5 °C ~ 35 °C (41 °F ~ 95 °F)	
Operating Humidity	10 % ~ 75 %	
Weight	48 kg (105.8 lbs.)	
Dimensions (W x H x D)	760 mm (29-7/8") x 645 mm (25-3/8") x 511 mm (20-1/8")	
Discs played		
DVD disc (DVD-Video, DVD-R)	12 cm (5") single-sided, single-layer 12 cm (5") single-sided, double-layer 12 cm (5") double-sided, double-layer (one layer per side) 8 cm (3") single-sided, single-layer 8 cm (3") single-sided, double-layer 8 cm (3") double-sided, double-layer (one layer per side)	
DVD-RAM	5" (12 cm) 9.4 GB (double-sided) and 4.7 GB (single-sided) 3" (8 cm) 2.8 GB (double-sided)	
Compact disc (CD-DA, CD-R, CD-RW)	5" (12 cm) disc 3" (8 cm) disc	
Digital audio output		
Optical digital output	Optical connector	
Pickup		
Wavelength	655 nm (DVD) 790 nm (CD) Laser power: CLASS II	

Note

- Designs and specifications are subject to change without notice.

Index

A	
Accessories.....	2
ACTION button.....	11
AC Power Plug.....	13
ADD/DELETE/CLEAR button.....	11
Add or Delete a Channel.....	19
ANGLE button.....	11
ANGLE Indicator.....	12
Audio Adjustment.....	29
AUDIO button.....	11
Audio Input Connector 1.....	13
Audio Input Connector 2.....	12
Audio Menu.....	28
Audio Mode for TV Viewing.....	24
Audio Mute.....	23
Audio Output Connector (L/R).....	13
Audio Soundtrack Language.....	41
Auto-Power Off function.....	38
Automatic Channel Setting.....	19
Automatic Clock Setting.....	20
Auto Shut Off.....	37
B	
Before Requesting Service.....	60
Blocking Message.....	36
Blue Screen Display.....	37
C	
Canadian English Language Ratings.....	34
Canadian French Language Ratings.....	35
Caption On Mute Feature.....	27
Change Language Setting.....	21
Changing your secret code.....	31
Channel Display.....	37
CHANNEL UP/DOWN button.....	11
Closed Caption Mode Feature.....	26
Connecting the "1, 2" AV Input Terminals.....	15
Connecting the Audio Output Terminal.....	16
Connecting the RF in Terminal.....	14
D	
Direct Navigator.....	45
Discs that can be played.....	9
Disc Handling.....	10
Disc Languages.....	54
Disc Operation -Using Information Screen-.....	46
Disc Tray.....	12
DISPLAY button.....	11
DST (Daylight Saving Time).....	8
DVD button.....	11
DVD Volume Adjust.....	52
E	
Enter Secret Code.....	31
F	
Forward/Reverse Chapter/Track Skip.....	39
Forward/Reverse Rapid Scene Search.....	39
Frame by Frame Picture.....	39
I	
Important Safeguards and Precautions.....	6
Information Display.....	43
Initial Setup (Ready to Play).....	18
INPUT button.....	11
L	
Language Code List.....	55
Loading the Batteries.....	8
Location of Controls.....	11
M	
Main Menu of DVD.....	40
Manual Clock Setting.....	20
MENU/PLAY LIST button.....	11
Multiple Angle Viewing.....	53
MUTE button.....	11
N	
NUMBER Keys.....	11
O	
ON-TIMER.....	25
ON TIMER Indicator.....	12
OPEN / CLOSE.....	11
Optical digital audio output connector.....	13
P	
Phones Jack.....	12
Picture Zoom.....	43
Play a DVD-RAM.....	44
PLAY button.....	11
Play Disc.....	38
Play List.....	45
POWER button.....	11
Program Play.....	50
Program Repeat Play.....	51
R	
Random Play.....	51
Rapid Tune.....	23
RAPID TUNE button.....	11
Receivable Broadcast Types.....	24
Region Management Information.....	10
Remote Control Buttons.....	11
Remote Sensor.....	12
Reset all unit Memory Functions.....	21
RESUME Function.....	39
RETURN.....	11

S	
Safety Precaution.....	2
Safety Precautions.....	4
SEARCH /SLOW+	11
SEARCH /SLOW-.....	11
Selecting AUDIO OUTPUT.....	56
Selecting Input Mode.....	22
Selecting STILL MODE.....	57
Selecting TV MODE.....	58
SELECT ▲▼◀▶ button.....	11
SET button	11
SKIP+	11
SKIP-	11
Sleep Timer.....	25
SLEEP TIMER Indicator.....	12
Slow Motion Picture	39
Spanish Quick Use Guide.....	62
STILL.....	11
Still (Pause) Picture.....	39
STOP button.....	11
Subtitle Language	42
SUB TITLE button	11
SURROUND/VSS button.....	11
Surround Sound System.....	23

T	
Table of Contents	3
TIMER	11
Time Zone Adjust	21
TITLE/D.NAVI button	11
Title Menu of DVD.....	40
To clean disc surface	10
To View a Blocked Program/Movie.....	36
TV.....	11
TV Status & Clock Display	37

U	
Unit Buttons.....	12
Using the CH/VOL Button.....	22
Using the Number and 100 keys.....	23
Using the NUMBER keys [Disc].....	39
US MOVIES Ratings	32
US TV PROGRAMS Ratings.....	33

V	
V.S.S. (Virtual Surround Sound).....	53
VHF/UHF Antenna Input Terminal	13
Video Adjustment.....	29
Video Input Connector 1	13
Video Input Connector 2	12
Video Menu	28
Vocal selection for Karaoke discs	41
VOLUME UP/DOWN button	11

W	
Warning and Instruction Displays	59
Z	
ZOOM button	11



LSQT0836 A

Panasonic Consumer Electronics Company,
Division of Matsushita Electric Corporation of America
One Panasonic Way Secaucus, New Jersey 07094

Panasonic Sales Company ("PSC"),
Division of Matsushita Electric of Puerto Rico, Inc.
Ave. 65 de Infantería, Km. 9.5
San Gabriel Industrial Park, Carolina, Puerto Rico 00985



Printed in Indonesia
LSQT0836 A
S0304-1034